



International Waterski & Wakeboard Federation

2011

Tournament Water Ski Rules

December 28, 2010

Version 1.4

Edited by:

Robert K. Corson

Chairman

IWWF Tournament Council

Please mail comments to bcorson@comcast.net

Revisions

24-Feb-2011

14.05 Updated to allow Gate Buoys to be 20-28cm in diameter

Diagram 9 updated

31.03.2011

Renumbering rule 15.03

ADDITIONAL RULES

IWWF Record Capability and Ranking List Tournament Standards

	World Record	Ranking List
Number of Rounds	4	4

Rule 1 GENERAL

- 1.01: Applicability of the Rules
- 1.02: World Championships Dates
- 1.03: Exceptions to the Rules
- 1.04: Interpretation of the Rules
- 1.05: Amendments to the Rules
- 1.06: Effectivity of the World Championships
- 1.07: Voting of the Judges
- 1.08: Identifying Bibs (2009)
- 1.09: Drug Testing
- 1.10: Unsportsmanlike Conduct
- 1.11: Tolerances
- 1.12: World Championship Site Practice Guidance

Rule 2 TOURNAMENT EVENTS

- 2.01: Events
- 2.02: Rounds
- 2.03: Schedule of Events
- 2.04: Schedule Changes
- 2.05: World Championships Entry and Administration (2009) (2010) (2011)
- 2.06: Control of the site
- 2.07: Site Selection for the World Championships

Rule 3 DIVISIONS OF COMPETITION

- 3.01: Divisions

R. 4 TOURNAMENT ENTRY REQUIREMENTS

- 4.01: Team Selection (2009) (2010)
- 4.02: Skier Eligibility
- 4.03: Two Event Qualification
- 4.04: One Event Qualification
- 4.05: Rating Effectivity
- 4.06: Three Event Qualification
- 4.07: Minimum Team Qualification

R. 5 OVERALL AND TEAM COMPETITION

- 5.01: Qualification for Individual Overall Scoring
- 5.02: Round Selection for Overall Score
- 5.03: Individual Overall Scoring Method
- 5.04: Overall Placement
- 5.05: Team Scoring
- 5.06: Overall Event

Rule 6 JUDGES AND ASSISTANTS

- 6.01: Chief Judge - Appointed Officials
- 6.02: Choosing Appointed Judges
- 6.03: Event Judges
- 6.04: Score Sheet Availability
- 6.05: Placement of Judges
- 6.06: Judges' Statement
- 6.07: Secondary Positions
- 6.08: Official Uniforms

Rule 7 SAFETY

- 7.01: Safety Director (2011)
- 7.02: Safety Tournament Stoppages
- 7.03: Personal Floatation Devices
- 7.04: Equipment Safety
- 7.05: Unsafe Skier Disqualification
- 7.06: Safety Boats
- 7.07: Safety Boat Personnel

- 7.08: On Site Medical Facilities

- 7.09: Helmets

Rule 8 RERIDES

- 8.01: Team Representative
- 8.02: Reride Criteria (2010) (2011)
- 8.03: Granted Reride Procedure (2008)
- 8.04: Requests for Rerides
- 8.05: Use of Flags

Rule 9 PROTESTS

- 9.01: Who may Protest and How it is done (2010)
- 9.02: Allowable Reasons for Protests
- 9.03: Protest Submission Procedure (2009)
- 9.04: Computation Error Procedure

Rule 10 BOATS - SKIS - TOW LINES

- 10.01: General Boat Description (2010)
- 10.02: Who may ride in the boat
- 10.03: Skis
- 10.04: Tow Lines (2011)
- 10.05: Ski Lines for the Trick Event
- 10.06: Skier Supplied Handle in Slalom and Jump (2011)
- 10.07: Speed Control(2009)
- 10.08 Radio Communication
- 10.09 Boat Manufacturer's Equipment

10.10 Boat GPS Speed Control and Timing Setup

R. 11 BOAT SPEEDS AND TOLERANCES

- 11.01: Boat Speeds (2009)
- 11.02: Tolerances (2009)
- 11.03: Accuracy of Timing Devices

Rule 12 DEFINITIONS

- 12.01: Competition Area
- 12.02: Definition of a fall
- 12.03: Definition of Skiing Position

Rule 13 JUMPING

- 13.01: General Jump Event Conditions
- 13.02: Description of the Jump Ramp
- 13.03: Jump Speeds
- 13.04: Boat Timing (2009) (2011)
- 13.05: Number of Jumps in Eliminations and Finals
- 13.06: Officials stopping a jump
- 13.07: Scoring of a jump
- 13.08: The result of a skier falling
- 13.08a: Skier Path (2011)**

- 13.09: Officials

- 13.10: Jump Distance Measurement

- 13.11: Distance

- 13.12: Scoring

- 13.13: Ties

- 13.14: Safety Equipment

Rule 14 SLALOM

- 14.01: General (2009)

- 14.02: Entering the Course (2009)

- 14.03: Boat Times (2009)

- 14.04: Slalom Towers

- 14.05: Buoys

- 14.06: A miss or "Riding Over"

14.07: Scoring Buoys (2011)
14.08: The end of the run
14.09: Event Scoring and Placement (2009)
14.10: Ties (2011)
14.11: Slalom Judging(2009) (2011)
14.12: Re Run
14.13: Damaged Equipment (2009)
14.14: Safety Equipment
14.15: End Course Video (2009)
14.16: Driver Times

Rule 15 TRICKS

15.01: Entering the Course
15.02: If a skier falls
15.03: General
15.04: Boat Speed
15.05: The Trick Course (2009) (2011)
15.06: Timing for the Trick pass will start (2010)
15.07: The trick pass shall end
15.08: Proceeding through the two trick passes (2010)
15.09: The skier shall set the speed
15.10: Communication with the Judges
15.11: Officials (2009) (2010)
15.12: Timing the Trick Pass (2009) (2010)
15.13: Credit for Tricks
15.14: Tricks at the End of the Pass
15.15: Use of the Video Camera (2011)
15.16: Trick Lists
15.17: Scoring
15.18: Ties
15.19: Trick Descriptions and Values (2010)

Rule 16 RECORDS

16.01: What Records are recognized
16.02: Tournaments where records may be set

16.03: Jump Records
16.04: Slalom Records
16.05: Trick Records
16.05a: Overall Records (2009) (2010)
16.06: Ties in an Event
16.07: Record Forms and Criteria(2009)(2010) (2011)
16.08: Record Administration Rules

17 OPTIONAL RULES

17.01: Head-to-Head Competition

Rule 18 Ski Flying

18.01: Ski Flying general definition and conditions
18.02: Ski Fly Tow Lines
18.03: Ski Fly Ramp
18.04: Ski Fly Pylon Specifications
18.05: Ski Fly reference buoys for spectators
18.06: Ski Fly boat minimum qualification
18.07: Ski Fly boat speeds
18.08: Ski Fly World Records

Ski Fly Jump Course

Ski Fly Jump Course Buoy Colors

HOMOLOGATION GUIDELINES

1. Slalom
2. Tricks
3. Jump
4. Dossier
5. Speed Control

TRICK VALUES (2009) (2011)

ADDITIONAL RULES

JUNIOR COMPETITION RULES (2009) (2010)

1. Skiers who may participate
2. Technical Rules

IWWF Under 21 Division Rules (2009) (2010)

IWWF Seniors Divisions Rules (2010)

World Cup Rules

WORLD RANKING LIST DESCRIPTION AND SCHEDULE (2009)(2010) (2011)

DIAGRAM 1 - OFFICIAL SLALOM COURSE

DIAGRAM 2 - OFFICIAL JUMP COURSE (2011)

DIAGRAM 3 - OFFICIAL TRICK COURSE (2009) (2011)

DIAGRAM 4 - Optional Jump Course Turn Buoy

DIAGRAM 5 - Optional Slalom Course Turn Buoy and Pre-Gates

DIAGRAM 6 - Slalom Judging Tower Placement

DIAGRAM 7 - Pylon Specification Drawing

DIAGRAM 8 - Allowable Floating Course Structure

DIAGRAM 9 - Handle Measurement Device Dimensions

COMPUTER BENCHMARK FOR COMPUTED DISTANCES deleted

Specific Inscribed Circle Algorithm Description

RAMP SETTING CHART

Official Homologation Dossier for L & R Tournaments (2009)

INTERNATIONAL WATER SKI FEDERATION

WATER SKI TOURNAMENT RULES 2010

These rules supersede all previous editions and addenda and shall remain in effect until an amended edition of the rules is published. The 2007 Rulebook is the base rulebook although years of change are notes on specific rules. **All changes for 2008 will be designated in red. All changes for 2009 will be designated in green. All changes for 2010 will be designated in purple. All changes for 2011 will be designated in orange. The general changes due to the name change of the IWWF from the IWSF will remain in black.**

These rules have been drafted in English. In the case of conflicting interpretation, only the English text shall be considered authentic. All correspondence regarding these rules should be addressed to the Chairman of the Tournament Council: Mr. Robert K. Corson, 23 Fox Hollow Road, Voorhees, New Jersey 08043, U.S.A.

email: tcchairman@iwwfed.com

Rule 1 - GENERAL

1.01: Applicability of the Rules

The rules set forth here govern tournaments sanctioned by the International Water Ski Federation. With the exception of entry requirements and other administrative matters, the Regions must follow these rules for their sanctioned tournaments. It is requested that Federations establish rules as close to these rules as possible. Whenever the masculine is used, the same shall be construed as meaning the feminine where the context so requires.

1.02: World Championships Dates

The World Championships shall be held biennially in odd numbered years.

The World Junior Tournament Championship shall be held biennially in even numbered years.

The World Under21 Tournament Championship shall be held biennially in odd numbered years.

The World 35+ Championships shall be held biennially in even numbered years.

1.03: Exceptions to the Rules

Where compliance with the rules is not feasible, the Chief Judge shall, with the approval of the majority of the Appointed Judges, make the necessary changes, inform each contestant by posting, and send a report to the Tournament Council. Where the rules are definite and feasible, a vote of the Judges to decide whether to enforce any provision is prohibited.

1.04: Interpretation of the Rules

Questions of interpretation of the rules shall be referred to the Tournament Council when possible. Any interpretation made by the Tournament Council as a whole shall be considered final. Otherwise the interpretation shall be made by a majority vote of the Appointed Judges, and the Chief Judge shall make a report to the Tournament Council concerning the question.

1.05: Amendments to the Rules

Amendments made prior to the biennial revision of the rules must be approved by a two-thirds (2/3) majority of the members of the Tournament Council. The rules may be amended at any time by the Tournament Council. The amended rules shall become effective sixty (60) days after they are sent to each affiliated Federation except in the case of new tricks submitted prior to September 30, which may be added by simple majority, and become effective immediately on November 1. All new tricks submitted must include a video showing the trick. Until such time as a new biennial edition of the rules is published, the current rules, as amended by the Tournament Council, remain

in effect. A unanimous decision of the members of the Tournament Council is immediately applicable.

Under the authority of the Tournament Council Chairman, proposed rules may be tested. The Chairman shall determine the appropriate homologation level under the test conditions. A complete report of the results of the test will be made by the Homologator and Chief Judge and sent to the Chairman for distribution to the Tournament Council.

1.06: Effectivity of the World Championships

The inability for one reason or another of a country to attend any World Tournament (including political reasons) does not require that the entire competition be cancelled or postponed or that the titles are any less world titles.

1.07: Voting of the Judges

Unless otherwise specifically stated, every vote of the Appointed Judges or the Event Judges shall be decided by a simple majority of the judges voting. In the event of a tie, the Chief Judge shall cast the tie-breaking vote. All issues should be settled before the next contestant starts.

1.08: Identifying Bibs

It may be required that skiers must wear identifying bibs while skiing. The bibs must be of a design approved by the Chairman of the IWWF Tournament Council. The central feature of the bib will be an identifying number on both the front and back of the bib. The individual digits of the number must be a minimum of 15 cm in height and be clearly visible from a distance. The design must allow for use of an arm sling in jumping and also be snug so that it does not interfere with the free movement required in tricks. The bibs will be given to each team captain before the competition for distribution to his team. Spare bibs, with no numbers, should be available at the starting dock in case a skier's bib is damaged and unusable. Skiers must each wear the bib with the number assigned to them only. **A Refusal by the skier to wear the bib will result in disqualification from that event. However, accidental leaving off the bib not noticed in advance by anyone will incur a fine of US\$250 payable to the event organiser.**

1.09: Drug Testing

All competitors must agree to be subject to doping control. Specific policies and procedures regarding doping control shall be under the control of the Medical Commission of the International Water Ski Federation.

1.10: Unsportsmanlike Conduct

Any contestant (or his representative) or official whose conduct is deemed unsportsmanlike or whose conduct may cause discredit to the IWWF, either on or off the tournament site, before, during, or after the tournament, may be disqualified from all or part of the tournament including completed events and/or be subject to a fine to be determined by the IWWF Executive Board, by a two-thirds majority vote of the Appointed Judges. The affected individual will be given an opportunity to present his case before a disqualification decision is made. In the case of a finding of unsportsmanlike conduct, a report must be submitted by the Chief Judge to the Chairman of the IWWF Tournament Council. If the Executive Board assesses a fine, it will be paid by the skier's Federation.

1.11: Tolerances

All tolerances are to allow for human error and the intentional use of tolerances by tournament officials to improve skier performance will not be tolerated. In any activity involving the performance of an official where a tolerance is involved, it is the official's responsibility to attempt to be as close as possible to the actual specification.

1.12: World Championship Site Practice Guidance

As a guidance for Organizers - If practice is to be offered at a cost to teams then a deadline date (latest 60 days before the scheduled start) should be set by which time all requests must be submitted. After this deadline practice times should be allocated to ensure all countries have an equal opportunity according to their request.

Rule 2 - TOURNAMENT EVENTS

2.01: Events

The events in a tournament are jumping, slalom, and tricks, with a champion and succeeding places determined in each event. A champion and succeeding places shall also be determined for the Overall and for the National teams as described in Rule 5.

2.02: Rounds

Each event shall consist of two rounds; a preliminary round and a final round.

All skiers qualified to ski in an event must ski in the preliminary round of that event.

A skier must score (more than 0) in the preliminary round to qualify for the final.

Basic Rule

The first twelve placed skiers based on the results of the preliminary round, shall be qualified to ski in the final round of that event. There shall be no differentiation between individual skiers and team skiers.

Ties

In the case of a tie for any position which may result in more than twelve skiers going through to the final round there will be a run off between the tied skiers so that only twelve skiers go into the finals.

For all IWWF World Championships except the Open World Championships, the number of skiers qualified to ski in the Final round of an event shall be as shown in the following table and will be announced immediately after the end of the Preliminary round of the event:

Number of skiers started in Preliminary round	Number of skiers in Finals
1 - 5	All
6 - 10	first 5
11 - 12	first 6
13 - 15	first 8
16 - 19	first 10
20 and more	first 12

2.03: Schedule of Events

Not later than two months before the start of the tournament, the Tournament Chairman shall send to each affiliated Federation, by air mail, a schedule showing the days on which the tournament events will be held. The schedule of events for both the preliminary and final rounds shall be drawn up by the Chief Judge, the Chairman of the Tournament Council and the Tournament Chairman and posted prior to the start of the first event. This list shall include starting time for each day. A schedule of starting times for individual events, if shown, shall be for the guidance of the contestants only, and any deviation shall not constitute a change. It is recommended that jumping be scheduled as the last event in both the preliminary and final rounds.

2.04: Schedule Changes

Changes in the schedule during the tournament shall be made only for weather, water conditions, safety, or a similar reason. A majority of the Appointed Judges must approve the change, and all affected contestants shall be notified by posting. Although schedule changes are to be discouraged, the Judges should not hesitate to make adjustments required for safety. Once the tournament has started, the Judges do not have the authority to cancel any event, except in the case of a definite safety hazard; and, if possible, the tournament must be completed, even if the Judges are obliged to continue it in a neighboring community.

If by a 2/3 majority decision, the appointed judges decide it is impossible to complete the final round of one or more events in either division only the overall points from the preliminary round of all the events in that division will be used for overall placement and team scoring. In this case if an event final cannot be completed, placement in that event shall be based on the preliminary round results.

2.05: World Championships Entry and Administration

Each Federation shall certify to the Chairman of the Tournament Council and to the organizing committee, not later than 60 days before the scheduled start of the first event of the World Championships, its intent to compete. Any Federation not meeting this requirement will not be allowed to compete until they pay a fine of 200 **US Dollars** to the IWWF. Each Federation shall certify to the Chairman of the IWWF Tournament Council, the Chairman of the Region Tournament Council, and the organizing committee, not later than ten (10) days before the scheduled start of the first event of the World Championships, the names of the members of its team, the events each will enter, the ratings of each skier, as well as the names of the official reserves. Any Federation not meeting this requirement will not be allowed to compete until the Federation pays a fine of ten (10) **US Dollars** per skier per day after the 10-day deadline to the IWWF for each skier not officially entered. If the official entry forms are not received prior to the 24 hours before the start of the first event, the Federation's skier's places in the draw shall be determined by the Chief Judge without reference to their qualifying scores. There is no limit on official reserves per team.

The day before the start of a preliminary round the entry list shall be closed and thereafter the order of contestants will be finalized and posted. No change in this order is allowed except that a team representative may:

- Withdraw a skier from the competition.
- Replace, with the authority of the Chief Judge and before the start of the first event, that is to say before the first skier taking part in the first event has started, an injured skier by a qualified official reserve from the same team.
- The substitute skier shall start first in the seed in which he is qualified unless the draw has not yet been completed.

The competitors for the **Open World Championships** will be drawn in the following manner:

- **The most recently published World Ranking List will be used to make a general classification list of all the skiers entered in the World Championships. Skiers with no performances on this list will be subject to a random draw in the lowest series.**

If a skier is not on the current list, but is on the previous year's list, that number will be used with a 25% penalty. The procedure will be as follows: All skiers on this year's list will be seeded and the seed groups set. If a skier has a seed number from the previous year of, for example 40, that number +25% or 50 in the example will be used to decide what seed group the skier will ski in. That skier will be added to that seed group as the first skier on the water from that group.

An overall skier may have an overall ranking, but not be on the event list. In this case the performance level will be used to pick the seed number. If it is from the previous year the

same 25% penalty shall apply. This will determine the seed group. That skier will be added to that seed group as the first skier on the water from that group.

- **The skiers will then be divided into groups and the start list will be made using reverse order of the ranking list scores.** The group size will normally be 15 men and 10 women but may be changed before the start of the tournament by the Chief Judge. (Cf., however, 13.01 for jumping order in the men's event). It is recommended that Series 1 and 2 for women and Series 1, 2 and 3 for men be scheduled so that these skiers will have similar conditions.

The competitors for all Age Category World Championships will be drawn in the following manner:

The best scores (entry scores) either submitted or from the ranking list will be used for seeding purposes.

Once the seeding has been done from the entry scores, the skiers will be divided into groups as above, but the start order is drawn randomly within each series.

The Event Judges may reverse or change the starting order of these groups according to the prevailing conditions.

The order of the skiers qualified for the final round in any event shall be the reverse of their order of placement in the preliminary round of that event.

The order of contestants tied in placement shall be settled by random draw.

Any contestant who fails to be on hand and ready to ski when the boat is prepared to start shall be disqualified from the remainder of the event; however, the dock official may grant up to one additional minute of time for emergencies developing or discovered just prior to the contestant's turn to ski (e.g. ripped binding).

In the case where a skier has been disqualified or has scratched, a one-minute delay shall be granted to the next skier in the starting order if he was not on the starting dock at the time of disqualification. If more than one skier has been disqualified or has scratched, the time allotted to the next skier shall be one minute for each skier disqualified or scratched.

2.06: Control of the site

Once homologation starts, use of the site is under the authority of the Chief Judge until the completion of the tournament.

2.07: Site Selection for the World Championships

As a basic principle, there should be only one site chosen for the running of the events. A second site should not be used unless absolutely necessary.

Rule 3 DIVISIONS OF COMPETITION

3.01: Divisions

Competition in each event shall be separated into a Men's and a Women's division. There shall be no age limitations on entrants.

Rule 4 - TOURNAMENT ENTRY REQUIREMENTS

4.01: Team Selection

Each Federation which is affiliated with the IWWF shall have the right to select a team of skiers to represent their Federation in the World Championships. The team shall consist of a maximum of six skiers, with the further limitation that no team may have more than four men or four women.

Skiers not selected for their national teams may qualify to compete in the World Championships as individuals only in the relevant event(s) if they meet one or more of the following criteria:

1. World record holder. The performance must have been ratified by the Tournament Council and the President of the IWWF 30 days before the first day of the World Championships.
2. Top 6 of the **previous year's** World Cup placements
3. The following placements on the **current year's** May IWWF Ranking List
 - o **Mens Slalom 20**
 - o **Womens Slalom 15**
 - o **Mens Jump 20**
 - o **Womens Jump 15**
 - o **Mens Tricks 20**
 - o **Womens Tricks 15**
 - o **Top 10 in overall, Men and Women**
4. The following placements on the **previous year's** May IWWF Ranking List
 - o **Mens Slalom 16**
 - o **Womens Slalom 12**
 - o **Mens Jump 16**
 - o **Womens Jump 12**
 - o **Mens Tricks 16**
 - o **Womens Tricks 12**
 - o **Top 8 in overall, Men and Women**
5. The following placements on the Elite Ranking List **30 days before the World Championships.**
 - o **Mens Slalom 14**
 - o **Womens Slalom 10**
 - o **Mens Jump 12**
 - o **Womens Jump 8**
 - o **Mens Tricks 8**
 - o **Womens Tricks 8**
6. The following placements on the Elite Ranking List **one year and 30 days before the World Championships.**
 - o **Mens Slalom 11**
 - o **Womens Slalom 8**
 - o **Mens Jump 9**
 - o **Womens Jump 6**
 - o **Mens Tricks 6**
 - o **Womens Tricks 6**
7. Reigning World Champion in any event or the overall from the previously held World Championships.

All skiers qualified as individuals must be entered by their Federation.

Skiers entering as individuals shall not have their scores count toward team standings.

The Rankings List used shall be the most recently published list.

4.02: Skier Eligibility

A Federation may select its team in any manner it desires; however, each team member must be a citizen or applying for citizenship of the country which the Federation represents. In case of doubt as to the nationality of a competitor, the Judges normally will refer to his passport. If a skier does not have a passport from the country for which he is skiing, he must prove residence in the country for at least five years and membership in an affiliated club of the Federation. Each Federation shall certify to the Judges that all members of its team meet these qualifications.

4.03: Two Event Qualification

Each skier entering at least two events (except those competing under Rule 4.07) shall have in his possession a rating card showing the following skiing classification in each event which he enters:

	Tricks	Slalom	Jumping
Men	4000 Points	6@16m & 4@14.25m (58 km/h)	43m
Women	3200 Points	6@16m & 4@14.25m (55 km/h)	31m

4.04: One Event Qualification

Each skier entering only one event (except those competing under Rule 4.07) shall have in his possession a rating card showing the following skiing classification in the event which he enters:

	Tricks	Slalom	Jumping
Men	5500 Points	6 @ 13m (58 km/h)	49m
Women	4000 Points	6 @ 13m (55 km/h)	34m

4.05: Rating Effectivity

Rating cards shall be certified under the responsibility of the Chairman of the Tournament Council of the Region, or his designated representative, based on performance in tournaments sanctioned by the IWWF, a Region, or an affiliated Federation. If the ratings are more than one year old, the Chairman of the Tournament Council of the Region must satisfy himself that the skier is still qualified. Rating cards so certified shall be accepted by the Judges without further examination.

4.06: Three Event Qualification

If a skier is qualified under 4.03 to compete in two events, he shall be allowed to compete in the third event if he possesses a valid rating card showing the following skiing classification in the third event.

	Tricks	Slalom	Jumping
Men	3000 Points	6 @ 18.25m (58 km/h)	36m
Women	2300 Points	6 @ 18.25M (55 km/h)	25m

4.07: Minimum Team Qualification

Each Federation shall be entitled to a team of three competitors, male or female, whether qualified under rules 4.03 and 4.04 or not. Such a skier who is qualified in only one event or not qualified in any event may compete in only two events. In addition, the Federation organizing the World Championships shall be entitled to a team of six competitors, whether qualified or not.

Rule 5 - OVERALL AND TEAM COMPETITION

5.01: Qualification for Individual Overall Scoring

To qualify for an overall score, a competitor must score at least 20 points in tricks, 1/4 buoy in slalom and have one scoring jump.

5.02: Round Selection for Overall Score

Individual overall results shall be calculated on the better score of either the preliminary or the final round for each skier qualified for the individual overall. Scores obtained in running off a tie shall not counted towards overall.

5.03: Individual Overall Scoring Method

Each overall competitor shall be awarded in each event a certain number of overall points according to the relationship of his best score in either the preliminary round or the final round to the best score in the event during either round by a skier who is qualified as an overall skier.

The best performance in an event in either round by an overall skier shall be awarded 1000 points and be referred to as the "Best overall skiers score". All other performances shall be calculated according to the following formulae:

For Tricks (skiers best event score x 1000) / Best Overall Skiers score

For Slalom (skiers best event score x 1000) / Best Overall Skiers score

For jumping the formula is different for men and women:

Men: ((skiers best event score minus 25m) x 1000) / (Best Overall Skiers score minus 25m)

Women : ((skiers best event score minus 17m) x 1000) / (Best Overall Skiers score minus 17m)

A skiers overall score in jumping shall not be reduced below zero.

5.04: Overall Placement

Individual Overall placement is based only on better score of either the preliminary or the final round.

5.05: Team Scoring

In team competition, the best three Team scores, men or women, in each event (in the eliminations or finals) shall be summed up to obtain the team score.

The best performance in an event in the preliminary or final round by a team skier shall be awarded 1000 points and be referred to as the "Best Team Score". All other performances shall be calculated according to the formulae in 5.03 substituting "Best Team Skier's Score" for "Best Overall Skier's Score".

The performance by a skier who is not an official member of his Federation's team shall not be taken into consideration in the calculation of the team score.

Team scores are separate and distinct from Individual overall scores.

Rule 6 - JUDGES AND ASSISTANTS

6.01: Chief Judge - Appointed Officials.

At least six (6) months prior to the start of the World Tournament, the President of the IWWF shall appoint the Chief Judge for the World Tournament from among the Chief Judges proposed by each Region Tournament Council.

The President of the IWWF shall appoint for the World Tournament the Homologator, the Chief Calculator, and the assistant to the Chief Judge from among the officials proposed by each Region Tournament Council.

The Appointed Judges shall be selected by each Regional Council. All appointed judges must be qualified in all three events.

The appointment of the assistant to the Chief Judge must be made with the Chief Judge's approval.

The President of the World Tournament Council shall appoint a Chief Boat Driver and 2 to 3 additional boat drivers from among those proposed by each Region Tournament Council.

A maximum of two boat drivers may be from the country organizing the Tournament.

Assignment of the drivers to individual events shall be made by the Chief Boat Driver.

The Chief Judge shall supervise all judging and scoring operations and shall select the Judges and the assistants for each event. (For the choice of the Jury for each event, refer to articles 13.09, 14.13, 15.11).

The Chief Judge, who must not serve as an Event Judge, shall assign to his assistant those duties he deems appropriate.

Official	Nomanated by	Appointed by	Timeframe
Chief Judge	Confederation Councils	IWWF President	6 months before start
Assistant Chief Judge	Confederation Councils	IWWF President	6 months before start
Homologator	Confederation Councils	IWWF President	6 months before start
Chief Scorer	Confederation Councils	IWWF President	6 months before start
2 Assistant Scorers	Confederation Councils	IWWF WTC Chairman	6 months before start
3 Judges from PANAM	Confederation Council	PANAM Council	6 months before start
3 Judges from E&A	Confederation Council	E&A Council	6 months before start
3 Judges from AA	Confederation Council	AA Council	6 months before start
1 Additional Judge	Confederation Councils	IWWF WTC Chairman	6 months before start
Chief Driver	Confederation Councils	IWWF WTC Chairman	6 months before start
2 – 3 Drivers	Confederation Councils	IWWF WTC Chairman	6 months before start

6.02: Choosing Appointed Judges

The Judges chosen for the World Tournament must represent the Regions as follows:

Region I - 3 Judges minimum

Region II - 3 Judges minimum

Region III - 3 Judges minimum

A total of 10 judges shall be selected.

Each region will nominate a person for the 10th judge to be selected by the Chairman.

The Chief Judge and his assistant are not included in the above number.

If a Region is unable to propose the specified number of qualified Judges, the IWWF Tournament Council can appoint additional Judges from other Regions.

If two events are to be run at the same time on different sites, the IWWF Tournament Council must appoint 3 extra Judges.

Any additional judges recruited during an event to assist become event judges only. They are not appointed judges.

6.03: Event Judges

For the World Championships, the Event Judges must be chosen by the Chief Judge from among the Appointed Judges, preferably as follows:

For Slalom - no more than two judges from any one Region.

For Tricks - the best panel appropriate for the level of trick performances

For Jumping - one Judge per Region.

At other tournaments, the selection to the event judges shall be governed by Region administrative practice.

6.04: Score Sheet Availability

The scoring sheets of each judge for every skier shall be made available for a period of 30 minutes for inspection by the team captain as soon as the provisional results are posted. Under the team captain's responsibility, a skier may view his own scoring sheets.

If a skier's score sheet is changed based upon this review, the changed sheet will be available for inspection for a period of 15 minutes after the revised results are posted assuming that this would not be less than the initial 30 minute limit. Each time a sheet is changed, it will be available for another 15 minutes for review.

If specific results are asked to be reviewed by the officials by the team captain, a notice shall be posted to the effect that some scores are under review and naming which skiers. This can be done by marking the posted results or by separate notice.

For tricks, judges using shorthand other than the official codes shall have a sample of their shorthand posted showing their mark for each of the official codes per the table in the rulebook.

6.05: Placement of Judges

Where practical, Judges shall be separated to ensure completely independent opinions.

6.06: Judges' Statement

The Chief Judge and each Appointed Judge shall sign a statement on the prescribed form at the conclusion of the tournament that the Rules were followed implicitly, noting any exceptions allowed.

6.07: Secondary Positions

Personnel to fill secondary positions shall be selected by the Chief Judge from among other experienced Judges and Officials in attendance. Wherever possible, Officials filling complementary positions (for example, boat driver and boat timer, top and bottom meter readers, etc.) should be of different nationalities. ~~Boat Judges in Tricks should be chosen from among the Appointed Judges or from other first-class Judges in attendance.~~

6.08: Official Uniforms

It is recommended that officials wear standard uniforms consisting of a white polo shirt and navy blue shorts. If heavier clothing is required due to the weather, the same colour scheme shall be maintained of a plain white top and navy blue slacks/pants.

Rule 7 - SAFETY

7.01: Safety Director

At least two months before the tournament, the organizing Region Tournament Council shall appoint a Safety Director, who will appoint such assistants as appear necessary and inform the IWWF President and the IWWF Tournament Council Chairman. The Safety Director shall be responsible for the safe conditions of all equipment, facilities and operation of the tournament; but this shall not prevent him from delegating specific responsibilities to his assistants as approved by the Chief Judge. He shall have the authority to take whatever action is necessary, including stopping the tournament, whenever he observes a condition he believes unsafe. The Chief Judge may overrule any contemplated action or decision of the Safety Director on his own responsibility.

Every tournament shall have a designated Safety Director and medical and safety arrangements shall be made appropriate to the size, rating and location of the tournament.

7.02: Safety Tournament Stoppages

Should the Safety Director stop a tournament for any reason, disqualification time periods (2.05, 13.01, 14.01, 15.08) shall not run as long as the tournament is stopped. The Safety Director should remain near the competition area as much as possible.

7.03: Personal Floatation Device (PFD)

It is the responsibility of each skier to ensure their PFD meets the following specifications:

- a) It must be smooth and soft and free from attachments or material likely to cause injury in a fall.
- b) It must be constructed and fastened in such a manner that it is unlikely to be torn loose or damaged so as to render it useless in a hard fall.
- c) It must float the skier.
- d) It must not be an inflatable device.
- e) It must be constructed so as to provide adequate protection from impact damage to the ribs and internal organs. A normal wet suit shall not be considered adequate protection in this respect.

A PFD must be worn in slalom and jump but is at the skier's option in tricks.

7.04: Equipment Safety

The Safety Director shall determine whether equipment to be used by a contestant meets safety specifications.

7.05: Unsafe Skier Disqualification

No skier shall be allowed to compete or to continue to compete if, in the opinion of the Safety Director and a majority of the Event Judges, his competing would be a danger to himself or other skiers in the tournament. During the competition, the Safety Director may, at any time, request the Chief Judge to halt the tournament for a poll of the Event Judges in regard to a skier's actions or conditions. Whenever practical, the advice of a doctor should be obtained.

7.06: Safety Boats

Two safety boats shall be used during all events.

The suggested positioning is:

- a) Slalom Events - operating outside of course between No. 2 and No. 5 skier buoys.
- b) Jumping Events - operating opposite side of ramp, out-side of jump course buoys facing skier's anticipated point of landing.
- c) Trick Events - operating outside of course buoys facing skier during pass.

At certain sites, where it is practical and feasible, with the approval of the Safety Director, and per the IWWF Safety Manual, rescue teams may operate from shore.

7.07: Safety Boat Personnel

Each safety boat will be manned by:

1. An experienced driver who is familiar with the conduct of all practice and tournament events.
2. A swimmer, also familiar with all practice and tournament events as well as being fully trained in First Aid, Emergency Resuscitation and Water Rescue Techniques.

The swimmer will wear a life jacket at all times and, in the event of a serious fall, will jump into the water to assist the skier. If the injured skier is unable to climb into the safety boat with little or no assistance, the skier will be floated to shore and lifted from the water on a suitable board or stretcher. Under no circumstances will an injured skier be lifted passively over the side of the safety boat. It is emphasized that, in international competition, language difficulties may interfere with communication; and, for this reason, the swimmer **MUST GET IN THE WATER** to assist the injured skier.

7.08: On Site Medical Facilities

The Safety Director will appoint a Tournament Medical Officer who will undertake to provide the following services:

- 1) A suitably qualified medical officer will be in attendance during all tournament events.
- 2) A suitably equipped medical station prepared to deal with any sort of medical emergency will be conveniently located at the tournament site.
- 3) Suitable transportation facilities that will allow an injured skier to be moved safely and promptly to the best local medical unit for further care.
- 4) A working relationship will be established between the local hospital or medical unit and the Tournament Medical Officer, such that casualties will get prompt and expert treatment when required.

7.09: Helmets

Skiers must wear a suitable helmet in the jump event.

Rule 8 - RERIDES

8.01: Team Representative

Each Federation shall select a team representative whose name shall be given to the Chief Judge before the start of the first event. The team representative shall represent all skiers from his federation. An alternate team representative may also be named.

8.02: Reride Criteria

When unfair conditions or a malfunction of the tournament committee-supplied equipment occurs, which, in the opinion of a majority of the Event Judges, adversely affects a contestant, he shall be granted the option of a reride only on the passes affected. **In the case of optional re-rides the score may only be protected for failure of tournament supplied equipment or under those circumstances explicitly defined in these rules.**

When a skier receives an unfair advantage, the reride is mandatory. When taken, the reride is scored.

Failure to establish a time through the course in slalom or jump is considered a malfunction of equipment and a reride will be given. The score is not protected.

If a skier's turn in jump or slalom or tricks is interrupted between passes due to the above listed circumstances, and the interruption causes a delay exceeding ten (10) minutes, then the skier shall be allowed a free warm up pass/ jump with a protected score on passes already completed. The warm-up pass is not scored although the skier will be given the distance in the case of jump. **The timing for the 10 minutes shall be from the moment the problem occurs or the boat is stopped (whichever comes first).**

8.03: Granted Reride Procedure

Rerides must be taken no later than five minutes after they are granted and may be taken immediately at the option of the contestant (cf. 14.14 for slalom rerides and 13.15 for jumping rerides). If the contestant elects to take a five-minute rest, the next contestants in order shall ski, and the reride shall be taken at the conclusion of the skier's run during which the five-minute rest period expires. **However, the rest time will not be allowed to affect the skiing order if it is seeded or in the finals of a major tournament.**

8.04: Requests for Rerides

Requests for rerides may be initiated by a Judge for the event before the next contestant starts or may be initiated, as soon as possible, by the contestant or his team representative and shall be decided as soon as practicable thereafter. If, in the opinion of the Judges for the event, the request was not initiated as soon as possible after the contestant skied, the request shall be denied.

8.05: Use of Flags

When a mandatory reride occurs, a red flag must be shown in the boat. When a skier is granted an optional reride and elects to take it, a green flag must be shown in the boat.

The flag must be shown during all movements of the boat outside of the competition course.

Rule 9 – PROTESTS

9.01: Who may Protest and How it is done

Protests shall be made to the Chief Judge only by a team representative and shall be considered by the Appointed Judges. Protest must be made in writing, must state the reason(s) for the **protest and quote the relevant rule number(s)**, and must be filed as soon as possible, but no later than 30 minutes after the results of the event are announced and the Judges scoring forms are available for inspection.

9.02: Allowable Reasons for Protests

Protests shall be allowed only for failure of the tournament committee, officials, judges, calculators to comply with these rules and only if this non-compliance with rules has an adverse effect on a skier. No protest shall ever be permitted on a judgment decision by the Judges.

9.03: Protest Submission Procedure

Protests must be accompanied by the approximate equivalent in local currency of 25 **US Dollars**.

- This amount will be refunded if the protest is considered reasonable by the Judges.

9.04: Computation Error Procedure

A correction of an error in the computation of scores shall not be considered a protest, and the correction shall be made upon approval of the Chief Judge and Chief Scorer if requested within two hours after the results of the event are announced and the Judges' scoring forms are available for inspection.

Rule 10 - BOATS - SKIS - TOW LINES

10.01: General Boat Description

For IWWF Towboat Approval refer to Official IWWF Towboat Policy.

- a) Boats must have the performance necessary to attain and maintain the required boat speeds while towing a heavy skier under tournament conditions.
- b) Overall length shall be approximately 5 meters but must not exceed 6.5 meters. The beam shall be not less than 1.80 meters and not more than 2.50 meters.
- c) Boats shall be equipped with a towing pylon on the centerline of the boat, approximately amidships which shall be a minimum of 65 cm. and a maximum of 1.20 meters above the water when the boat is standing still with no occupants aboard. The entire pylon assembly shall be of fail-safe construction, designed to withstand a minimum loading of 600 kg. through an angle of 70° from the stern on both sides.

The towing pylon shall have an area integrated in its design for attachment of a trick release mechanism. It is recommended that this area be included both above and below the tow rope attachment location and be located as required to insure clearance of the rope and/or trick release mechanism from the engine housing. This area for attachment of the trick release mechanism shall be cylindrical with a diameter of 50.8mm, +0.00mm, -0.25mm, and a minimum height of 28mm. A centering hole with a diameter of 6.000mm, +0.35mm, - 0.0mm, and a minimum depth of 1.8mm shall be located on the centerline of the attachment area height and be oriented toward the front of the towing pylon. Any manufacturer not wishing to comply shall be responsible to see that trick releases fitting his pylon are available at tournaments where his boats are used. (See Diagram-7).

- d) Either inboard, inboard/outboard, or outboard power may be used.
- e) A maximum of 4 different makes and models of boats shall be chosen from among those boats approved by the IWWF Tournament Council in accordance with the obligations. **A minimum of two identical boats must be made available for each make and model chosen. The IWWF Tournament Council and the IWWF Federations shall be notified of the choice of boats at least 6 months before the start of the tournament and which boat shall pull each event 3 months before the start of the tournament.** Full information (engine size, prop pitch, etc.) on each boat shall be published a minimum of 3 months before the start of the tournament.
- ~~f) The boats must be equipped with adequate two-way radios.~~
- ~~g) The boats must be equipped with at least two accurate speed measuring devices operating on separate pickup tubes.~~
- h) The towboats for each event shall be chosen, from those provided, by the Chief Judge and the host Region's Tournament Council Chairman.
- i) For Jumping and Slalom, identical boats must be used by contestants in an event. For Tricks, the skier may select any one of the types of boats chosen for the tournament. Two teams of drivers and boat officials may be assigned to the Trick event at the option of the Chief Judge. The driver may be changed by the Chief Judge if he deems it necessary due to the length of the event. The Chief Judge may decide to use alternating identical boats to eliminate lost time and to speed up the running of the event.

10.02: Who may ride in the boat

Only designated persons may ride in the boat during the competition. (See Rules 13.09, 14.03, 14.11, and 15.11).

10.03: Skis

- a) Maximum ski width shall not exceed 30 percent of the overall length.
- b) Any type of fixed foot bindings may be used.

- c) Devices affixed to the ski intended to control or adjust the skiing characteristics of the ski are allowed as long as they are fixed in that they do not move or change during actual skiing.
- d) No other devices are permitted.
- e) Skis must be safe. There must be no unnecessary sharp or abrasive (to the touch) metal, wood or other attachments to the ski which could, in the opinion of the Safety Director, inflict injury to the skier should he come in contact with the ski in a fall.

10.04: Tow Lines

The Tournament Committee shall furnish single-handle 23 m and 18.25 m tow lines constructed as in (d) below, made of 6 mm., single braided, monofilament line of plastic material, with the handles and lines meeting the following specifications:

- a) Number of Strands = 12
 Minimum Number of Yarns each strand = 60
 Minimum Diameter at 5.5 kg. load = 6.3 mm.
 Weight per meter: 23.0 grams/meter maximum
 Breaking load, minimum = 590 kg.
 Elongation at 115kg tensile load: 2.4% +/- 0.8%.
 The gauge length shall be set at 5.5 kg. tensile load.
 All measurements of tow lines shall be made under 20 kg. tension and shall be made between the following points as applicable: (1) the **inside edge** of the handle at the point furthest from the attaching loop; (2) the inside surface, furthest from the handle, of any attaching loop.
- b) Samples of the tow line material to be used by the Tournament Committee shall be supplied to the Chairman of the Tournament Council no less than one year before the tournament for testing and approval. Following approval, the Tournament Committee shall make the line available to any affiliated Federation at a reasonable cost.
- c) Splices shall be 15 cm. (minimum) long secured with tucks before and/or after the splice, or knotted to prevent slipping.
- d) The tow lines may be made in one section or alternatively in two sections consisting of a single line 21.5m long for jumping, and 16.75m long for slalom, and a handle portion 1.5m.
 One-piece lines are optional, but two-piece lines must be provided by the Tournament Committee, and 21.5m and 16.75m. portions must be made available. Multi-segment slalom lines may be used. The segments shall be colored in the same sequence as the loops as shown in 10.04 g).
- e) The handle shall be made of 2.50 to 2.80 cm. outside diameter material with no sharp edges or projections, with unpainted wood or other non-slip surface or coating. The attaching ropes must in all cases go through the handle and must be attached so there is no possibility of movement between the rope and handle when in use. The minimum certified breaking load of the handle shall be 270 kg. applied at the rate of 290 kg. for a minute at two load points 9 cm. apart at the center of the handle with the ends supported at the rope holes. The handle shall be attached to the rope so that it is perpendicular to the direction of the line. The handle measurements specified in 10.04 (g) is the end-to-end length of the handle.
- f) Tow lines to be used for the Slalom event shall have loops spliced into the line at distances from the handle of 16m, 14.25m, 13m, 12m, 11.25m and 10.75m to permit quick change of line length.
 Additional loops should be added if there is a reasonable expectation that they will be used. The lengths are as follows:
 - o 10.25m
 - o 9.75m
 - o 9.50m
 Due to the physical difficulty of adding splices for a 25cm shortening, a different rope may be used for the 9.5m shortening if necessary.

A tolerance of plus or minus 15 cm. on the distance from the loop to the handle is allowed for the rope lengths at 18.25m, 16m, and 14.25m.

From the 13m rope length on, this tolerance is reduced to plus or minus 7.5 cm.

The loops may be colour coded to help differentiate between them. If the rope is colour coded, the following sequence must be used:

- o 18.25m red
- o 16.0 m orange
- o 14.25m yellow
- o 13.0 m green
- o 12.0 m blue
- o 11.25m violet (blue/white)
- o 10.75m white
- o 10.25m pink
- o 9.75m black
- o 9.50m rosso

The end loop on the rope need not be colour coded.

The shortening should be done by putting the loop directly over the pylon.

g) Dimensions shall be as follows:

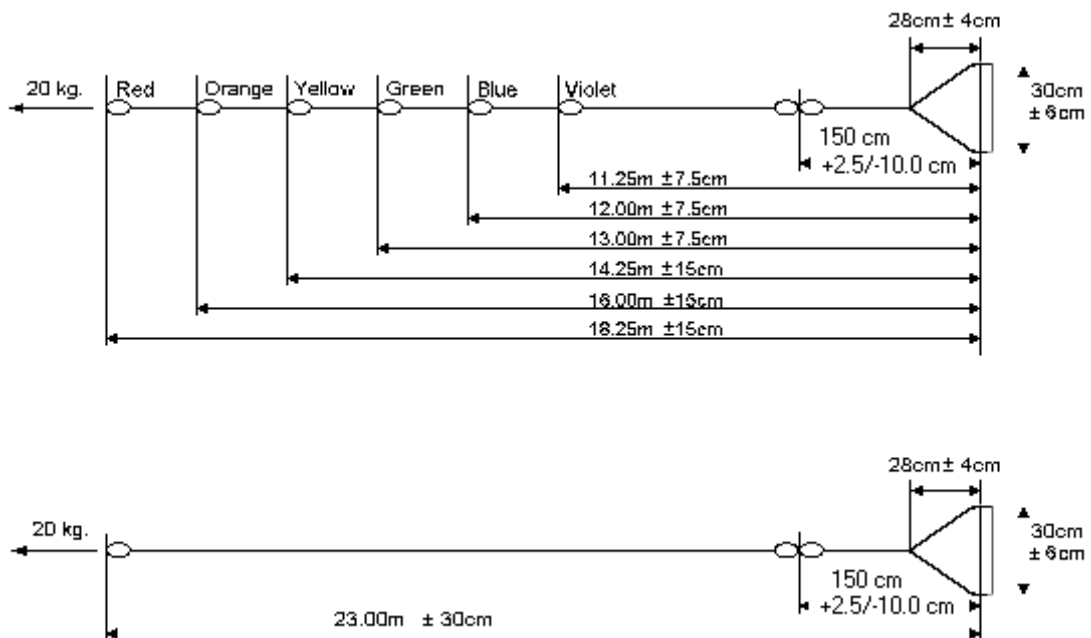

h) Differing rope specifications

Organizers should supply a rope of a certain allowable specification and continue to use ropes of that same specification for the entire event, both preliminaries and finals. This does not prevent using ropes of different specifications for different events as long as a rope of the same specification is used for the entire event.

- i) Slalom ropes must use a shock tube that is a minimum of 60 cm and a max of 1.2m
- j) A short segment of rope may be replaced by a substitute section for speed control rope tension measurement that will be at least as strong as the rope it replaces and cause no observable change in the rope performance. This section will typically be 0.5m. The remaining rope will be adjusted so that all lengths and tolerances are met from 10.04 g with the substitute section included.
- k) Optionally, in the jump event, on an experimental basis, a "Spectra" line may be supplied. In this case, a standard line must be available for use as well. The "Spectra" line specifications shall meet at a minimum the following requirements:

Breaking load, minimum = 590 kg.

Elongation at 115kg tensile load: 3.2% maximum

The skier may supply his own rope under his own responsibility which may be any combination of "Spectra" rope and/or normal rope (per 10.04 a). The skier must get the line checked by the homologator prior to skiing.

National Federations or Organizers may decide not to allow skier supplied ropes at smaller events.

10.05: Ski Lines for the Trick Event

The contestant must furnish his own line and handle for the Trick event of any length and of any dimensions or material.

10.06: Skier Supplied Handle in Slalom and Jump

For Slalom and Jumping, each contestant may furnish his own handle to be attached to the tournament line providing he notifies the starter, at the dock, at least three skiers on the starting list before his turn, of his wish to change handles.

The handle may be of any material.

The length of the handle attachment measured from the inside surface of the attaching loop furthest from the handle to **the inside edge** of the handle must be 1.50m +2.5cm / -10.0cm.

The handle must conform to the dimensions shown in 10.04 g.

10.07: Speed Control

Speed control will be required for the World Championships. The specific make and model of speed control will be announced when the boats are announced for the World Championships (see 10.01 e).

The speed control program version to be used will be announced 3 months prior to the relevant World Championships. That version must be available world wide and may not change until after the Championships.

The version will be posted on the homologation notice.

Further, speed control will be required for all Ranking list and Record tournaments starting Jan.1, 1998 and for the 1997 World Cup tournaments.

Some of the important points are as follows:

- a) If speed control breaks then go to manual. If a replacement unit or boat is not available, or the unit cannot be quickly repaired, then the tournament shall be continued with manual driving with performance restrictions for those performances done with manual driving. (These restrictions are noted in the Additional Rules section notes)
When the speed control cuts out or fails to operate or is a deviation from normal operation (i.e. a malfunction) the skier is entitled to a re-ride for failure of equipment and can improve the score.
- b) If the unit allows, the speed may be micro adjusted a set number of specific speed steps to compensate for wind or current conditions on a pass by pass basis under the control and/or observation of the boat judge.
- c) **The principle job of the speed control is to provide independence of the manual operator and to give in tolerance speeds, as close as possible to actual times.**
- d) The Boat Judge and the Driver shall jointly agree on the setting of the speed control and the allowed adjustments for wind conditions, etc., with the goal of having the machine produce actual times for each pass.
- e) If the boat officials feel that a significant change must be made in the setting for the jump event (i.e. one letter change) to obtain the proper actual time, they will notify the skier of the change when it is made, before his next jump.
- f) For each skier, a written record shall be kept of the initial setting of the speed control and any changes that are made during his turn.
- g) For jumping, the manufacturer's recommendations shall be used regarding any skier selections of parameters. For Perfect Pass, this means that a skier may select a letter in the range of plus or

minus three letters from the initial selection indicated by the weight of skier with equipment but without skis.

The skier's weight will be determined by using a scale on the dock weighing the skier in jump gear and equipment, but without skis.

In an elite cash prize tournament the skiers are allowed to use the World Record distance as their best.

- h) No back up time is required when using speed control
- i) Each currently manufactured speed control system has parameters that are to be set to provide proper and fair operation. Charts for the two major manufacturers are included and must be followed
- j) There must be a second display unit for the Boat **Judge in slalom and jump if the speed control system is not GPS based.**
However, a second display is require for slalom and jump for titled and Elite events regardless of the technology type.
- k) In slalom, the skier's weight will be determined by using a scale on the dock weighing the skier, but not the ski.

Official settings reference chart

[Speed Control Settings Chart](#)

Special Note: Speed Control systems are evolving and the most up to date information is incorporated into the Settings Chart. The IWWF is working closely with speed control manufacturers to ensure the devices meet competition needs. Notable changes are due to the incorporation of GPS which allows "virtual" buoy timing and may or may not be integrated with magnet systems. Only approved speed control systems will be supplied on tournament boats.

The ultimate goal is to minimize, if not eliminate variable input except for the chosen speed.

10.08 Radio Communication

Radio communication with a competitor while skiing is not allowed

10.09 Boat Manufacturer's Equipment

Variations or special equipment unique to certain boat manufacturers will be addressed in this rule.

a) Hydrogate

The Hydrogate can be set in one of two positions, Slalom or Tricks/Jump

Tricks – default is tricks/jump - skier can choose either slalom or tricks position and the skier may have the setting changed between passes.

Slalom/Jump - skier can choose the position on the dock before he starts. It will remain in that position for his turn.

10.10 Boat GPS Speed Control and Timing Setup

The GPS location set up should be according to manufacturers specification. The Homologator and Driver must check together that the set up is correct and according to the manufacturers guidelines.

Speed Control Parameter Adjustment Chart

Updated speed control parameters may be posted on the USA WS website, accompanied by a revision date, and will supersede the speed control parameters printed in the AWSA Rule Book. No changes shall be made between July 1 and the conclusion of Nationals.

JUMP

Parameter	Who	When	Perfect Pass	Zero Off
BOAT SPEED	Skier	Before each pass	Speed in MPH/KPH	Speed in MPH/KPH
SKIER - JUMP LETTER	Driver/Judge - with input from skier	Before each jump Boat crew may adjust as necessary including for the first jump	Select NEW JUMPER and input speed, skier weight and rated distance. Skier may adjust initial setting +/- 3 letters. Adjust as necessary	Hold "SEL" while jump letter is highlighted. Enter skier weight and rated distance. Skier may adjust initial setting +/- 4 letters. Adjust as necessary.
41METER SEGMENT				
SKIER - FAST or RTB (Return to Baseline)	Skier selects Fast or RTB	Before each skier based on type of 41 meter segment pull requested	S2% - Fast segment = 40 to 60 Return to Baseline = Zero	Letter Only = faster segment Letter with "RTB" above = return to baseline
BOAT ADJUST (Raises speed in the 41 Meter segment. Adds to the target speed)	Driver/Judge	Boat crew may adjust as necessary	S2 FINE - Fine adjust additional RPM as needed to speed up 41 Meter segment for actual times.	ADDER - Range = 0 to 9. Start at 0. Adjust as needed for actual times. This number follows "Power Factor". Example: 6/0 - Where 6 is the Power Factor and 0 is the "adder"
BOAT - POWER FACTOR	Driver/Judge - with input from skier	Start at 6 or 7 with 5.7 liter engine Start at 4 with 6.0 liter engine Boat crew may adjust as necessary	N/A	Range 0 to 15 - Raises or lowers the base speed. A lower number result in boat entering the course slower. At 3 or below there is no additional decrease in baseline (adjustments are then made to the ramp rate for the letter) Recommended: 180 Head Wind 190 Tail Wind 170 ¾ Cut 160
COUNTER CUT TIME (CT)	Driver	Before event May be adjusted as necessary to control speed during counter cut w/head or tail wind	Recommended: 175 Head Wind 190 Tail Wind 170 ¾ Cut 160	
CREW WEIGHT	Driver/Judge	Before event	Weight in lbs	N/A
RPM ADJUST	Driver	As needed	Adjust for conditions	N/A
X8u	Skier	The manufacturer's setting may be adjusted up or down within the range as published for that towboat. One additional adjustment may be made after the skier's 1 st jump only.	Controls rate of additional rpm added. With a higher number, it will take longer for the full additional rpm to be reached (softer at the start/stronger at the base).	N/A
X8d	Driver/Judge - with input from skier	The manufacturer's setting may be adjusted up or down within the range as published for that towboat. Before each skier	Controls the timing of the rpm drop once the skier has unloaded the switch. With a higher number, the longer it will take for the boat to begin to slow.	N/A

Speed Control Parameter Adjustment Chart

SLALOM

Parameter	Who	When	Perfect Pass	Zero Off
OPERATING MODE	Driver/Judge	Before event	TOURNAMENT MODE ONLY	TOURNAMENT MODE ONLY
BOAT SPEED	Skier	Before each pass	Speed in MPH/KPH	Speed in MPH/KPH
A1, A2, A3 B1, B2, B3 C1, C2, C3	Skier – skier's option. Set to default - B2 unless skier asks for other setting	Before each pass	N/A	A = Slowest engine response out of buoy B = Moderate engine response out of buoy C = Fastest engine response out of buoy 1 = Softest feel behind the boat 2 = Moderate feel behind the boat 3 = Firmest feel behind the boat N/A N/A
CREW WEIGHT	Driver/Judge	Before event	Enter total crew weight in lbs	N/A
SKIER WEIGHT	Driver/Judge	Before each skier No adjustment between passes	Set skiers weight: Zero – no skier Feather - < 120 lbs Light – 120 to 160 lbs Normal – 160 to 200 lbs X – 200 lbs	N/A
(PP CLASSIC) KX	Skier – should be set to Normal unless skier asks for other setting	Before each pass	KX - = softer KX NORMAL = default KX + / KX++ = firmer	N/A
(PP CLASSIC) PX	Skier – should be set to zero unless skier asks for other setting	Before each skier No adjustment between passes	PX = 0 to 40	N/A
(PP CLASSIC) RPM ADJUST	Driver	Adjust as necessary for conditions	Zero eliminates the switch Adjust for conditions	N/A
(PP CLASSIC) SSB	Driver	Adjust as necessary to balance speed between first and second segments of the course	Initial setting for each boat from mfg suggested settings - adjust as needed	N/A

TRICKS

Parameter	Who	When	Perfect Pass	Zero Off
BOAT SPEED	Skier	Before each pass	Speed in MPH/KPH	Speed in MPH/KPH
A1, A2, A3 B1, B2, B3 C1, C2, C3	Skier – skier's option. Set to default - B2 unless skier asks for other setting	Before each pass	N/A	Speed in slalom Above
Kd	Skier – skier's option. Set to default - unless skier asks for other setting	Before each pass	Default = 28	N/A

NOTE: If the designated towboat has multiple GPS systems available, the skier has the option to select from available GPS systems. If the tournament committee chooses to use older Perfect Pass Classic, then no choice is permitted.

Rule 11 - BOAT SPEED AND TOLERANCES

11.01: Boat Speeds

All speeds are speeds over the bottom. The boat path in all events is intended to be a straight line **and the speed must meet all indicated time chart requirements.**

11.02: Tolerances (see also Rule 1.11)

All indicated speeds in Slalom and Tricks shall be accurate to plus or minus one km/h. For a speed to be considered accurate, the maximum and minimum speeds recorded in the course, as noted by the official in the boat, must be within the tolerances allowed. In the Slalom event, the average speed in the course must fall within the tolerances allowed (Rule 14.03). The speed may vary a maximum of 1 km/h for a distance before entering the competition course and be maintained until the skier is out of the course. If, in the opinion of the official in the boat, the tolerance was exceeded, a reride will be mandatory if the speed variation was advantageous to the skier. If it was disadvantageous to the skier, he will have the option of a reride.

In the jumping event, it is the responsibility of the driver to set the speed control to the base speed and cut letter selected by the skier (see Rule 13.04). If the time does not meet the criteria in any segment, the driver will make the allowed appropriate adjustments to make it meet the timing chart. If, in the opinion of the boat judge, the speed before or after the timing course was a disadvantage to the skier, he will be given the option of a reride. It is intended that the speed control drive the boat at a constant speed through the 52m segment so that the speed the boat enters the 52m segment is the speed that it leaves the 52m segment.

11.03: Accuracy of Timing Devices

Timing devices in all events shall be accurate to at least 5 parts in 10,000 (.01 sec. per 20 sec.). Any timing device used in a tournament must be checked for accuracy by the Chief Judge, Homologator, or Tournament Council representative.

For a new design to be approved, the manufacturer must supply its test data and test method information to the IWWF Tournament Council for approval.

Rule 12 - DEFINITIONS

12.01: Competition Area

The suggested tournament layout is shown in Diagrams 1, 2, 3, 4 and 5. The dimensions of the courses shall be as indicated; however, the layout of the competition area may be varied to suit the tournament site. No buoys or markers other than those indicated by Diagrams 1, 2, 3, 4, and 5 and video jump measurement buoys are permitted within the competition area except to mark safety hazards, landing or starting areas, or turning buoys. Any such buoys shall be distinguishable from tournament buoys and shall be pointed out to skiers at the start of the competition.

The entrance of the courses for each event are defined as follows:

Slalom: The start gates of the slalom course on the first pass

Jumping: The 180m. buoy on each pass

Tricks: The first trick buoy on each pass

12.02: Definition of a fall

A fall in any event is defined as accomplished at the moment any one of the following occurs:

- a) The skier loses possession of the tow line;
- b) The skier does not have at least one ski on one foot; or
- c) The weight of the skier is not primarily supported by his ski or skis; and, in addition, the skier is ultimately unable to regain skiing position.

12.03: Definition of Skiing Position

Skiing position is defined as that position in which all of the following exists:

- a) The skier has possession of the tow line; and
- b) The skier is riding forward or backward with a ski or skis on his feet; and
- c) The weight of the skier is entirely supported by his ski or skis, or the skier is ultimately able to regain control.

Rule 13 - JUMPING

For the boat, see Rule 10.01, and for the tow lines 10.04 and 10.06.

13.01: General Jump Event Conditions

The skier shall be entitled to three jumps or passes or falls from the time he starts in the preliminaries and three jumps or passes or falls from the time he starts in the finals.

- a) Women jumpers will have the option of choosing either a height of 1.65 m. or 1.50m (see Rule 13.02d).
- b) Men jumpers will have the option of choosing either a height of 1.65 m. or 1.80m (see Rule 13.02d).

Only the length of the jump will be considered no matter what ramp height is chosen by the skier.

A skier qualified for the final round may change his chosen height of the ramp for the final round subject to a time deadline set by the Chief Judge.

Skiers jumping at each height will be drawn together and will ski before those jumping at the higher height setting in both the elimination and final rounds.

A fall shall not eliminate the skier from the following pass provided that fall is a result of a jump.

A contestant may refuse to enter the jump course by throwing the handle in the air. He shall not be penalized for so doing providing this refusal was for a reason judged acceptable by the Event Judges. To receive any consideration of a reride request for conditions before the 180m buoy, the skier must throw the handle before entering the course. Once having taken the jump the skier loses all right to a re-ride for conditions before the 180 m buoy. The skier must be ready to ski immediately upon the boat's return. Should the skier not be ready or should the reason be judged not acceptable by the Event Judges, one jump shall be deemed to have been taken. If a skier notices that his equipment is damaged (broken fin, binding, ski...), the Event Judges may grant him 3 minutes to repair or change the broken equipment and to continue competing.

In the case of a fall after a jump, the skier who is not back on his skis within three minutes (including any repair of equipment) after the towboat is ready to take him will not be allowed to complete any further jumps in that round. If the skier is ready before the three minutes expires, but the boat judge feels it might not be safe for him to compete he may ask the safety director to check the skier. During that time, the clock is stopped until the Safety Director decides if it is safe for the skier to continue.

13.02: Description of the Jump Ramp

The jumping ramp shall be an inclined plane with an apron on the right-hand side. The ramp shall meet the following specifications:

- a) Width: 3.70m to 4.30m at all points. 4.20m to 4.25m is recommended.
- b) Length out of water at all points.

Length out of water table			
Ramp Ratio	Minimum	Maximum	Recommended
0.235	6.40m	6.80m	
0.255	6.40m	6.80m	
0.271	6.40m	6.80m	6.75-6.80m

- c) Length under water: 50 cm. minimum.
- d) Ratio of ramp height at take off edge to ramp length out of water:
 - 0.271 +/-0.003 or 0.255 +/-0.003 for Men, at the skier's option
 - 0.235 +/-0.003 or 0.255 +/- 0.003 for Women, at the skier's option

Ratios are to be computed on both sides of the ramp, and the ramp height at the take off edge at the two corners may differ by no more than 2.5 cm. (See Ramp Setting Chart).

- e) Jumpers must notify the Chairman of the IWWF Tournament Council, the Chairman of the Region Tournament Council, and the organizers, on the official entry form, what their choice will be for the ratio mentioned in d) above.
- f) The surface must be flat with a maximum deviation of 2.5 cm. from a plane. This will be verified by two measurements.
 - Place a taut string from the lower right corner (jump course side) of the surface to the upper left corner of the surface and measure the maximum distance between the ramp surface and the string.
 - Place a taut string from the bottom center of the surface to the top center of the surface and measure the maximum distance between the ramp surface and the string.
 These distances are to be recorded and must not exceed 2.5 cm as stated above.
- g) An apron shall extend the full length of the ramp on the right hand side and be at least 30 cm. under water when the ramp is set for the 1.80m height in Men's divisions. Ramp aprons shall be of a different colour or shade from the ramp surface so as to provide a satisfactory contrast between apron, water and jump surface.
- h) 6.40 and 6.80 length markings, clearly identified, shall be placed on the apron and/or ramp surface so that they are readily visible. Older ramps with permanently embedded 6.70 m length markings shall also be allowed.
- i) A line visible from shore shall be painted at the center of and just below the take off edge for meter sighting purposes. The jumping ramp must be securely anchored in place so that the center takeoff edge will not vary more than the sighted width of the crosshair on both meters after coming to static rest. "Static rest" is the position assumed by the ramp in ambient water not affected by boat wakes, skiers' wakes or backwash.
- j) All measurements of the ramp shall be made under tournament conditions, including the weight of watering equipment, and not including the weight of a skier.
- k) The jump apron shall have a minimum angle of 28° from perpendicular and a maximum angle of 60°. The recommended angle is 45°.
- l) It is recommended that all jump surfaces (fiberglass) be of a red-orange colour. Wax surfaces on wood will remain their natural colour.

13.03: Jump Speeds

The boat speeds for the jumping event shall be chosen by the skier from those listed in Rule 13.04 up to the maximum allowed as follows:

- a) Men - 57 km/h
- b) Women - 54 km/h

13.04: Boat Timing and reride situations

The boat shall be timed in the jump course between buoys 15ST-19ST and 15MT- 19MT with an intermediate time 52m (1st segment) and full time 82 m (1st+2nd segment), and between buoys 15MT-19MT and 15ET-19ET for a 41m - 3rd segment in order to maintain the tolerances listed in the charts below.

It is mandatory to record the times for the 3 segments for all speeds (men and women) at RC and RL competitions and submit these times to IWWF for evaluation.

The times must be in a text file format and emailed to the Tournament Council Chairman (tcchairman@iwsf.com).

**TournamentCode;Division;Gender;Speed;Segment1;Segment2;Segment3;TimerType;SkierLastName;SkierFirstName;Round;Pass;Class;Boat;EngineSize example
09BEL08;Junior;M;48;3.95;6.16;3.13;17.30;PS;Huisman;Perr;1;3;L;MALXI;60**

Division: Junior, Open, Senior

For Record Capability, Ranking List and Elite events the published 3 segment times should be used when:

Open Men – speed 57 - above 60meters

Open Women – speed 54 - above 45 meters

Junior Men – Speed 51 – above 38 meters

Junior Women – speed 51 – above 38 meters

For distances below these specifications, the 1st segment tolerance check is not required. Segments “1+2” and 3 must be in tolerance in all cases except as otherwise noted in the appropriate Jump Timing Reride Chart.

Times must be recorded to the 100th of a second.

The times driven should be as close to the actual times as possible. This will be monitored by the Chief Judge.

The rules governing skier letter or distance selection apply for this mode as well.

In the case where a skier refuses the ramp or falls on the approach to the ramp, the maximum speed tolerance allowable for segment 1+2 shall be increased by .05 seconds. This may be done by either subtracting .05 seconds from the maximum speed tolerance or by adding .05 seconds to the time recorded. On a pass or a fall before the ramp, the third segment time will not be used

At the skier's option, the speed control mode may be set to either **RTB, meaning the case where the speed control just returns to the base speed setting in the third segment, or three segment mode where the boat is programmed to meet the three segment times.**

In certain situations, the tournament officials may decide to use the normal chart for all skiers. An example might be a U13 division.

RTB Mode (return to baseline)

	1st+2nd Segment (82 mt)			3rd segment (41 mt)		
Speed	fast	actual	slow	fast	actual	slow
57	5.11	5.18	5.25	2.52	2.59	2.66
54	5.39	5.47	5.55	2.66	2.73	2.81
51	5.70	5.79	5.88	2.81	2.89	2.98
48	6.05	6.15	6.25	2.98	3.08	3.17
45	6.45	6.56	6.68	3.17	3.28	3.39
42	6.90	7.03	7.17	3.39	3.51	3.64
39	7.42	7.57	7.73	3.64	3.78	3.94

Jump Timing Reride Chart

seg1+2	Seg3	ACTION
OK	OK	None
OK	F	mandatory reride only if distance is best distance in skiers turn
OK	S	optional reride (protected score)
S	OK	optional reride (protected score)
S	F	mandatory reride if best dist., otherwise optional with protected score
S	S	optional reride (protected score)
F	OK	mandatory reride
F	S	mandatory reride
F	F	mandatory reride

Generally speaking, if any time is too fast, then a reride for the skier is mandatory. If no times are too fast, but if any time is too slow, then a reride for the skier is optional. On a pass or a fall before the ramp, the 3rd segment time will not be used. All situations are detailed in the timing chart above.

If the 1st+2nd or 3rd segment is fast on a successful jump but the distance recorded is less than previous or following jumps in the round by the skier, then a reride will not be awarded.

Three segment mode

Boat Timing (Reference 11.02)

Speed	1st segment		1st+2nd segment			3rd segment		
Speed	fast	slow	fast	actual	slow	fast	actual	slow
57	3.25	3.36	5.11	5.18	5.25	2.36	2.40	2.46
54	3.43	3.54	5.39	5.47	5.55	2.54	2.59	2.66
51	3.63	3.75	5.70	5.79	5.88	2.68	2.73	2.81
48	3.86	3.98	6.05	6.15	6.25	2.84	2.89	2.98
45	4.11	4.25	6.45	6.56	6.68	3.01	3.08	3.17

~~The 3rd segment times only apply when the speed is at the maximum for the division. After the 3rd segment, the speed control algorithm will be to set the speed to the base selected speed. When the speed is below the maximum for the division, the third segment will not be used with the exception that it may not exceed the maximum speed time for the event division. (Please note that if this happens, it is likely that the speed control is not working according to the intended algorithm and the manufacturer and the TC Chairman should be notified). The manufacturer's algorithm in the less than maximum speed case is to set the mechanism to the base speed setting (no overspeeding and no underspeeding) in the 3rd segment.~~

Jump Timing Ride Chart at Maximum Division speed

Seg1	Seg2	Seg3	Action	Protected Score
OK	OK	OK	none	n/a
--	S	--	optional rered (protected score)	Yes
S	F	--	Mandatory Reride	No
OK/F	F		mandatory rered only if distance is best distance in skiers turn	No
F	OK	S/OK	optional rered (protected score)	Yes
S	OK	OK/F	mandatory rered only if distance is best distance in skiers turn	No
S	OK	S	optional rered NO protected score	No
F	OK	F	optional rered NO protected score	No
OK	OK	F	mandatory rered only if distance is best distance in skiers turn	No
OK	OK	S	optional rered (protected score)	Yes

The first row from the top that matches the situation is used

Jump Timing Ride Chart at below Maximum Division speed

Seg1	Seg2	Seg3	Action
OK	OK	not F for max speed	None
one segment is F for max speed and no segment is S			mandatory rered only if distance is best distance in skiers turn
one segment is F for max speed and at least one segment is S			mandatory rered only if distance is best distance in skiers turn, otherwise optional with protected score
No segment is F for max speed and seg1 or seg2 is S or F for requested speed			optional rered (protected score)

In the case where multiple reredes may apply due to fast third segment these shall be resolved taking the longest distance first.

13.05: Number of Jumps in Eliminations and Finals

Refer to Rule 13.01

13.06: Officials stopping a jump

A jump shall not be registered should the boat driver or the boat-judge/ official on board decide that there is a hazard because of dangerous water conditions, interference of another boat or other reason. The boat driver or the boat-judge shall then hold up his hand, or a red flag, and slow the boat a perceptible amount before the boat passes the ramp.

13.07: Scoring of a jump

A jump shall be scored when a skier passes over the ramp, lands and skis away with a tight line in skiing position without falling. If a skier falls as a result of a jump, he loses that jump. If he shall purposely touch any part of the tow line other than the handle while in the air, he shall receive no score for that jump.

13.08: The result of a skier falling

Every time a skier falls, it shall count as a registered jump. (Cf., however 13.01) If the falls more than once on a single pass through the jump course or return run, a jump shall be registered for each fall.

A jumper shall receive no further jumps in a round if, after leaving the boat's wake on a definite cut to the ramp, the jumper elects to pass between the boat course and the ramp, whether or not he retains the tow line.

13.08a: Boat Path

The jumper shall tell the boat driver at which distance and at what speed to pass the ramp, and the boat shall follow a straight path through the jump course at the specified distance from the right-hand side of the ramp.

For 2011, a center line video on the jump course will be required for World, Confederation and Elite events tournaments. Tapes will be submitted to and monitored by the Confederation Council.

13.09: Officials

There will be three Judges for the event. Two Judges will be stationed on shore. The third Judge will be in the tow boat. The two shore judges may also act as measurement judges if they have a full and direct view of the jump course.

The Boat Judge is authorized to give reruns under Rules 11.02, and 13.04.

There may be 2 or 3 people in the boat.

The boat judge shall observe the accuracy of the boat path and verify its speed by checking the speed measuring devices.

If a rerun is given because of a faulty boat path or an error in speed, it must be taken immediately, and the Boat Judge must hold up an appropriate flag during the return pass to indicate that a reride will be taken on the jump that has just been completed.

When there is a fast 2nd or 3rd segment, the boat judge shall signal the skier by crossing his arms at 90 degrees (in the sign of an "X") to show that the skier may have a potential reride.

If there are more than two (2) rerides, the skier shall have the option of asking for a five-minute rest before continuing.

The rest time will not be allowed to affect the skiing order if it is seeded or in the finals of a major tournament.

13.10: Jump Distance Measurement

Jump distances shall be measured by video computer measurement systems approved by the Tournament Council.

The Tournament Council may approve systems based on video technology provided that proper verification and proof is given to the Tournament Council at least 60 days before the proposed use.

~~To insure accuracy, it is recommended that each meter station be no more than 70m from the point of landing.~~

The point of impact is defined the point on the water surface closest to the ramp that is touched by the skier when he lands. The distance is calculated from the impact point back to the ramp and then an offset adjustment of 2.1m is added.

13.11: Distance

Jump distances shall be measured from a point at the water line directly below the center of the top edge of the ramp to the skier's point of impact in the water closest to the ramp (first point of impact) and then an adjustment offset of 2.1m shall be added. The distance shall be communicated to the skier after each scoring jump.

For the video system, there shall be two designated officials (from different countries at international tournaments) operating the system who shall jointly make a judgement decision on the impact point. The calculated distance shall not be displayed until the impact point is jointly judged.

Since video jump measurement is used, video backup methods (video taping) must be used. ~~or a standard meter system may be used.~~

If the skier is misinformed or not informed of the distance, then a re-ride shall be offered on the next jump. Based on the circumstances, the Event Judges shall decide if the score is protected and inform the skier when he is offered the re-ride.

13.12: Scoring

The longest jump of each round will be the only one counted. Event placement for skiers qualifying for the final round will be based on their final round results only.

Jump distances may not be scored in increments finer than 10 cm.

The better result obtained by the skier, in either the preliminary or the final round, shall count towards team score.

13.13: Ties

If a tie exists for first place, it shall be run off. If a tie exists for 2nd or 3rd place, placement shall be decided on the basis of the higher preliminary round score. If a tie still exists, it shall be run off. The run off shall have a new drawing for order. Each tied contestant shall be allowed two jumps or passes or falls with the longest jump being scored according to Rule 13.12. Repeated ties shall be run off in the same manner until broken.

13.14: Safety Equipment

All contestants in jumping events shall be required to wear approved life jackets (7.03).

It is strongly recommended that skiers wear jump pants especially adapted for water skiing and approved by the Tournament Council, or a person appointed by the Tournament Council, for this purpose.

Skiers must wear a suitable helmet in the jump event (see 7.04). Should a skier go over the ramp not wearing a helmet that jump will be disallowed.

Rule 14 - SLALOM

For the boat, see 10.01 and for the tow lines 10.04 and 10.06; for the tolerances see 11.02, 14.03 and 14.16. There may be 2 or 3 people in the boat for slalom

14.01: General

The contestant shall follow the tow boat through the entrance gate of the slalom course (Diagram 1), pass around the outside of any or all 6 buoys and proceed through the far end gate (constituting a pass), making the turn and returning through the course in a similar fashion, until he misses a buoy or a gate or falls. The boat shall follow a straight path within the limits of the boat gate buoys. The skier may elect to waive all passes below a selected rope length (or speed should the Event Judges lower the minimum starting speed). In such cases the skier may notify the dock official of his selected rope length (or speed) any time before he starts his run. A skier who fails to select his starting speed at the specified time, will start at the maximum starting rope length and minimum speed for the event. Further optional selection of slalom passes is also allowed. If a skier misses in a pass that follows an optionally skipped pass, he/she shall be scored as if the buoys were scored in the pass following the last completed pass.

The following speeds and tow line lengths shall be used for slalom:

		Men	Women
		Continuous	Continuous
1st Pass	18.25m rope	58 km/h	55 km/h
2nd Pass	16.00m rope	58 km/h	55 km/h
3rd Pass	14.25m rope	58 km/h	55 km/h
4th Pass	13.00m rope	58 km/h	55 km/h
5th Pass	12.00m rope	58 km/h	55 km/h
6th Pass	11.25m rope	58 km/h	55 km/h

In any further passes, the rope shall be shortened as shown in Rule 10.04 f).

If, in the opinion of the majority of the Event Judges, the water or weather conditions require it, the speed of the first pass may be lowered to 55 km/h or 52 km/h for men and 52 km/h or 49 km/h for women, and then proceed upward in speed in 3 km/h increments until the first normal pass is reached. Then the skier will proceed as shown in the table.

The Men's final round shall start at the 13.00m pass and the Women's final pass shall start at the 14.25m pass unless changed by the Event Judges (See above)

14.02: Entering the Course

A contestant may refuse to enter the slalom course by throwing the handle in the air. He shall not be penalized for so doing providing this refusal was for a reason judged acceptable by the Event Judges. The skier must be ready to ski immediately upon the boat's return. Should the skier not be ready or should the reason be judged not acceptable by the Event Judges, he shall be disqualified from the remainder of the event.

Between the start dock and the gate buoys on the first pass, if a skier notices that his equipment is damaged, the Event Judges may grant him 3 minutes to repair or change the broken equipment and to continue competing. Once a skier has passed through the entrance gates on his first pass, he may not refuse to enter the course for the following passes.

14.03: Boat Times

Boat speed will be verified by an automatic timing system.

Timing used for boat speed verification, shall be from the entrance gate to the boat gate following the buoy at which the last full point is scored in the pass.

Times must be recorded to the 100th of a second.

An official shall ride in the boat to check speed by verifying the times recorded by the speed control system and by observing the water speed measuring devices.

A separate display for the Boat Judge will be used for this purpose if the speed control system is not GPS based. However, a second display is required for titled and Elite events regardless of the speed control technology type.

The recorded time will be communicated to the Judge's Stand by radio.

BOAT SPD	Score:	0-0.5	1-1.5	2-2.5	3-3.5	4-4.5	5-5.5	All 6
KPH	Fm/To:	E-1	E-2	E-3	E-4	E-5	E-6	E-X
	Fast	1.64	4.15	6.67	9.20	11.73	14.25	16.00
58	Ideal	1.68	4.22	6.77	9.31	11.86	14.40	16.08
	Slow	1.71	4.28	6.84	9.41	11.97	14.53	16.16
	Fast	1.73	4.37	7.03	9.69	12.35	15.02	16.86
55	Ideal	1.77	4.45	7.13	9.82	12.50	15.19	16.95
	Slow	1.80	4.51	7.23	9.93	12.64	15.34	17.04
	Fast	1.83	4.62	7.43	10.24	13.05	15.87	17.72
52	Ideal	1.87	4.71	7.55	10.38	13.22	16.06	17.93
	Slow	1.91	4.78	7.65	10.52	13.39	16.25	18.13
	Fast	1.94	4.90	7.87	10.85	13.83	16.81	18.78
49	Ideal	1.98	5.00	8.01	11.02	14.03	17.04	19.03
	Slow	2.03	5.08	8.13	11.18	14.22	17.27	19.27
	Fast	2.06	5.21	8.37	11.54	14.71	17.88	19.98
46	Ideal	2.11	5.32	8.53	11.74	14.95	18.16	20.27
	Slow	2.16	5.42	8.68	11.93	15.18	18.42	20.56
	Fast	2.20	5.56	8.94	12.33	15.71	19.10	21.34
43	Ideal	2.26	5.69	9.13	12.56	15.99	19.42	21.68
	Slow	2.32	5.81	9.30	12.78	16.27	19.75	22.03
	Fast	2.36	5.97	9.60	13.23	16.86	20.50	22.89
40	Ideal	2.43	6.12	9.81	13.50	17.19	20.88	23.31
	Slow	2.50	6.26	10.02	13.78	17.53	21.27	23.74

The times driven should be as close to the actual times as possible. This will be monitored by the Chief Judge.

Where the speed is faster than allowable and the skier has not made a perfect pass, he shall have the option of a reride but shall not be scored less than the score obtained on the pass leading to the reride.

If the skier has an imperfect pass, the boat judge shall determine, by appropriate means, whether the skier wishes to take a rerun. If a rerun is to be taken, the boat shall immediately return through the course in an unscored pass; and the rerun shall then follow in the original direction through the course.

Where the applicable speed is slower than allowable, a rerun shall be mandatory. If the pass was not a perfect pass, the skier may not improve his score over that obtained on the slow pass, unless the speed is so slow that it is equal to or below the fast tolerance of the next slower pass. If the pass was a perfect pass (score is 6, skier to continue), the skier may choose to proceed to the next pass

instead of repeating the pass. If the skier then makes a perfect pass, he receives credit for both passes. If the pass is missed, he will receive credit for the buoys made as if it were the lower, skipped pass.

In the event a contestant inadvertently receives a speed higher or a rope length shorter than the intended pass, the skier will be given the option of receiving credit for the actual score, accepting credit for the originally requested speed or rope length (assuming a perfect pass), or taking a reride.

In the event a contestant inadvertently receives a speed slower or a rope length longer than the intended pass, the skier will be given the option of proceeding to the next pass which follows the intended pass (assuming the pass taken was perfect), or taking a reride, or receiving the score for what was actually skied.

If there are more than two (2) rerides, the skier shall have the option of requesting a five-minute rest before continuing. **The rest time will not be allowed to affect the skiing order if it is seeded or in the finals of a major tournament.**

Missed times - if the applicable segment time is missed the skier may accept the highest scores with a good applicable segment time, or receive an optional reride with a protected score equal to the highest score with a good applicable segment time. Note if no times are recorded rule 8.02 applies. Additionally, if the skier has made a complete pass, the skier may opt up at his own risk.

14.04: Slalom Towers

The slalom judging towers shall be braced structures having a platform with railing. The floor of the tower shall be a minimum of 3 m above the water surface.

They may either rest on the bottom or be securely anchored in position. The use of two slalom judging towers is mandatory, located on different sides of the slalom course, in suitable viewing positions. (Note alternate allowed variations are shown in 14.11)

The judging area on each side of the course shall be located within 44 degrees +/-3 degrees from the course centerline on a line passing through the center of the entry gates as shown in Diagram 6.

14.05: Buoys

- a) Colour of buoys shall be selected for maximum visibility. A fluorescent yellow or red paint is recommended.
- b) Guide buoys used within the slalom course shall be a different colour from the gate and slalom buoys used by skiers.
- c) Spherical guide buoys shall be a minimum of 22 cm. in diameter. Cylindrical or rectangular solid guide buoys shall have a cross sectional area greater than 75 sq. cm. and less than 450 sq. cm.
- d) Slalom skier buoys shall be 20 to 28 cm. in diameter. 20 cm. is recommended. Slalom gate buoys shall be **20 to 28 cm. in diameter. 20 cm.** is recommended. These buoys shall also be generally spherical above the waterline.
- e) Slalom buoys shall be of a lightweight, pliable material with smooth exposed surface.
- f) Each buoy shall have a strong loop for attaching anchor lines. The buoys must be attached to the anchor line by the use of a system that will tighten the buoy in such a way as to ensure that it does not move around from its position.
- g) Gate buoys shall be fastened so that they have **10-17 cm** of height out of the water (11.5cm recommended) Skier buoys shall be fastened so that they have 10-17 cm of height out of the water (10.0cm recommended)
- h) Cylindrical or rectangular solid buoys shall be fastened so that at least 15 cm but not more than 30 cm of the buoy is above the waterline. They shall appear vertical.
- i) If cylindrical or rectangular solid guide buoys are used, they shall be fastened so that the distance between the inside edges of the buoys (boat tunnel width) shall be 2.05m +/- 15 cm.

14.06: A miss or "Riding Over"

It is a miss to ride inside a buoy or outside the entrance or end gate or to ride over, straddle or jump over a buoy; but there is no penalty for grazing a buoy with a ski or part of the body.

"Riding over" shall be defined as hitting a buoy with the ski so as to move it significantly from its position or temporarily sink it. Hitting a buoy less severely shall be considered as "grazing."

A skier shall be judged as missing the entry or exit gate when the center of the ski passes to the outside of the center of the gate buoy as shown in the diagram below:

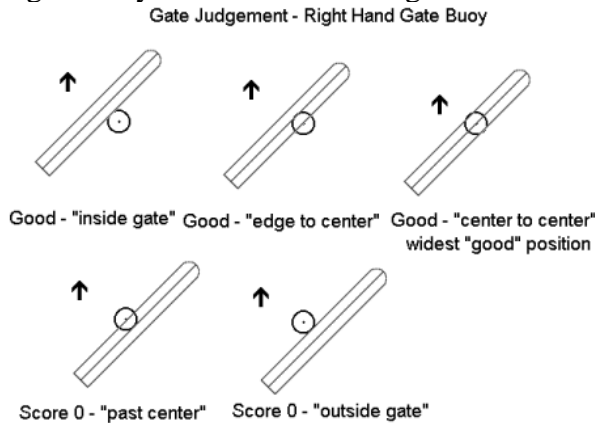

14.07: Scoring Buoys

A buoy not missed is scored as follows, up to the point of the first miss:

- 1/4 point when the skier crosses the line C-D AND the X-Y line in a skiing position (12.03). (See sketch).
- 1/2 point when the skier has re-crossed line C-D in skiing position (12.03) before the level of the next buoy or end gate.
- 1 point when the skier has crossed the line of the gate buoys (on a tight line under power of the boat) before passing the level of the next buoy (or the end gate in the case of the final buoy) without falling (12.02).

The intent of the tight line is to ensure the safety of the skier. This means that if the skier can only cross the line of the buoys with a slack line then he will not get the full point so there is no reason to try that. The end gate case is different because of the spacing and thus if the skier can cross the gate line before the end gate buoy and ski away he will be awarded the full buoy. **This specifically means that the skier is permitted to have slack going through the exit gates. If the skier skis away then they may continue. If the skier does not ski away, the turn ends and the skier scores 6 provided they crossed the line of the boat buoys before the end gate with or without a slack line. The skier may exit the gate with slack line.**

A gate is not scored in any manner.

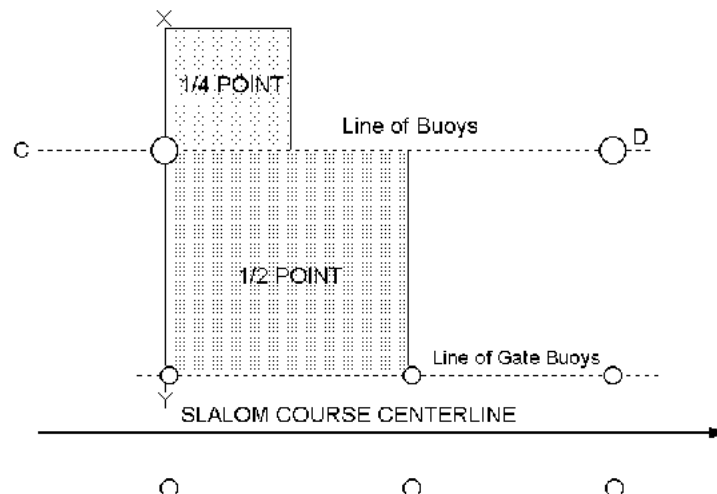

14.08: The end of the run

A contestant in either a preliminary or final round may continue to run the course as provided in 14.01 until he misses a buoy, entrance or end gate or fall, at which point his scoring ends for that round.

14.09: Event Scoring and Placement

Event placement for skiers qualifying for the final round will be based on their final round results only. The contestant with the highest score shall be the winner.

Six points shall be added to the contestant's score for each pass he elects to waive under the provisions of 14.01 provided his first pass is perfect. In the Men's finals, each contestant shall be required to waive at least **three passes** and six points shall be added to the contestant's score for each pass he elects to waive, as well as **eighteen points for the three** he was required to waive, provided his first pass is perfect. In the Women's finals, each contestant shall be required to waive at least **two passes** and six points shall be added to the contestant's score for each pass she elects to waive as well as **twelve points for the two** she was required to waive, provided her first pass is perfect. A contestant who waives one or more passes and whose first pass is not perfect shall receive only the points scored in that pass without additions for the passes waived.

14.10: Ties

If a tie exists for first place, it shall be run off. If a tie exists for 2nd or 3rd place, placement shall be decided on the basis of the higher preliminary round score. If a tie still exists, it shall be run off. The run off shall have a new drawing for order.

The tie breaking run shall begin with the scheduled speed and rope length of the last complete pass and conclude with the first miss. If another tie results, the tie shall be run off in the same manner with another new drawing for order. This process shall be repeated until a winner is determined. The skier may optionally skip any pass in the run-off.

When a run off for first place is between more than two skiers, all the places equal to the number of skiers in the run off are decided by the run off with no reversion to the preliminary round score except that the preliminary round score would be used if two or more skiers are still tied for 2nd and 3rd places after the run off.

14.11: Slalom Judging

Depending on technology available there are different ways of Judging slalom

5 Judges

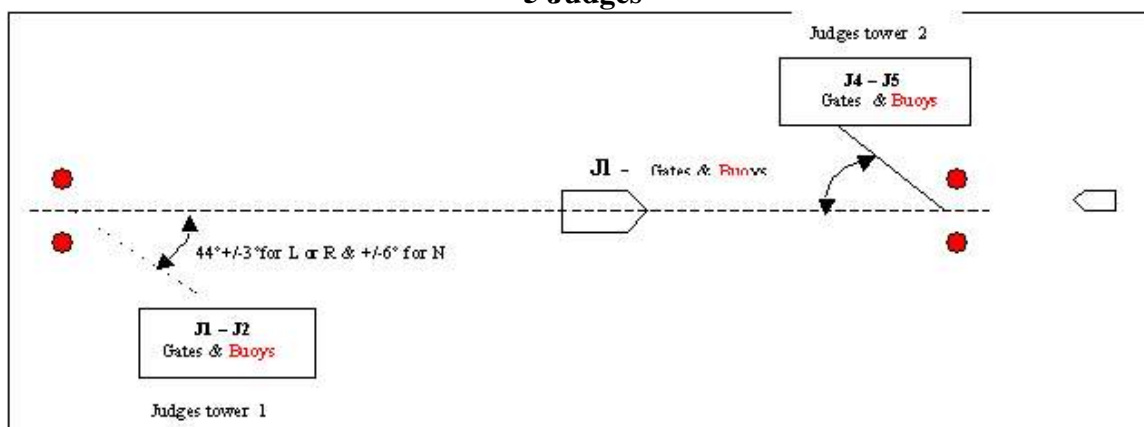

There shall be a Judge in the boat and two Judges in each of the slalom judging towers. The entrance and exit gates shall be judged by the two Judges closest to each gate and by the Boat Judge. Skier buoys shall be judged by all five Judges.

At the end of each run, the judges' will score the run as follows:

- The first decision to be made will be if the skier has gone through the entry gate. That decision will be made by the appropriate three judges as specified above.

- b) The second decision to be made is the skier's score by buoy count. A judge who might have felt that the skier missed the gate and thus scored 0 will continue scoring and state his final score as 0 with a continuation of X buoys where X is the score that he would have given the skier if he felt that the gate had been made.
- c) The scorer will first determine if the skier was judged as having made the gate. If the skier made the gate, the scorer will then award to the skier the highest score agreed upon by the judges based on their submitted scores. Thus if the scores are 1, 1, 3.25, 3.50, 3.50, the skier's final score is 3.25.

The scores called in by the judges will be considered final.

The score shall be finalized before the next competitor is permitted to start.

Gate camera

If it is not feasible to place a slalom judging towers at the prescribed angle, a video camera may be mounted at the proper angle and the camera feeds will be displayed on a monitor on a central judges tower, the Judges can observe the gate and the gate judgment will made from the monitor.

The signal will be taped so that review is possible. **A pole mounted boat camera may be used in conjunction with normal gate cameras to get a view that allows the most accurate result.**

The central Judges tower needs to be placed between buoy 2 and 5 on the relative gate-side of the course.

The size ratio of the gate buoys on the TV screen shall be 1/6th of the full width of the screen minimum with 1/3rd recommended.

Video gate review may be done at normal speed, slow motion or frame by frame in order to get the right score.

4 Judges with gate video

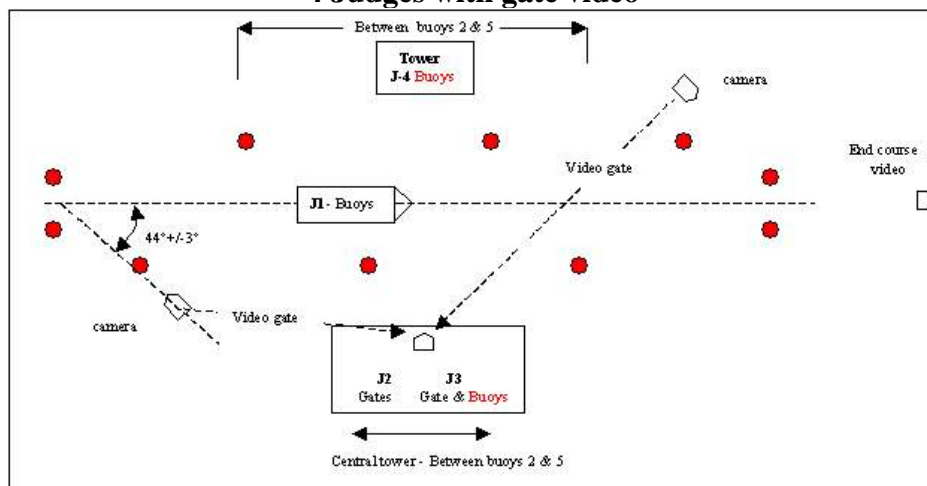

3 Judges with gate video

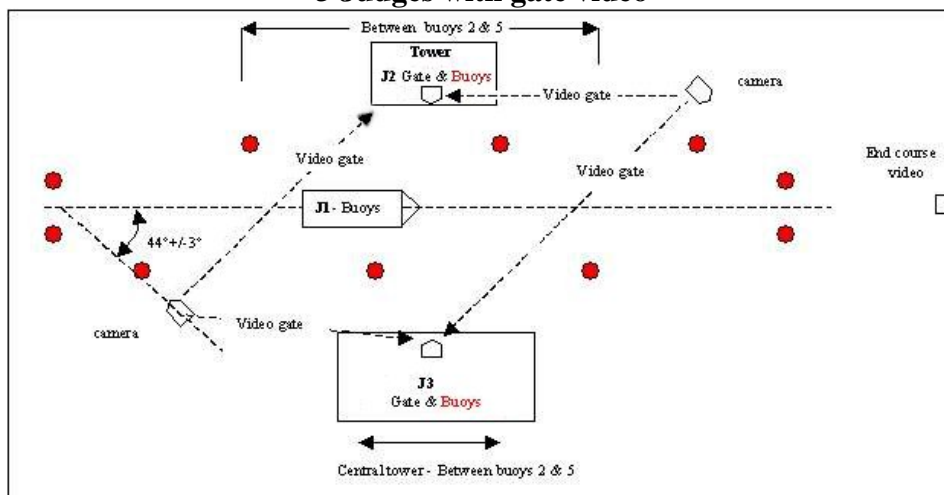

To use this Judging method all of the following need to be met

- Each gate must be judged by two judges using video feeds from cameras placed at the required angle to the gates at each end. These camera feeds will be displayed on a monitor and taped. Each Judge will independently call the entrance gate by observing the monitor. In this case only the tower judges determine the gate call. If one or both judges did not observe the entrance gate then the judge would replay the video to make the call. If both Judges disagreed the Chief Judge will cast the deciding vote. The exit gate will be viewed directly but the video may be used by one or both judges to resolve any questions.
- The skier buoy count will be made by the boat judge and two judges, one on each side of the lake in a symmetrical placement and within 44 degrees (or buoy 2) to the centre of the course. Unless boat video is used where the two shore judges may be on the same side in a central location between buoy 3 and 4 with the same height requirements.

It should be noted that there are other possible options and configurations but in all cases the number of judges required for gate judging and buoy judging is as detailed in the above paragraph. The exact number of judges will depend on if a particular judge has responsibility for the gate or the buoy, or both.

4 Judges with video gate and boat video

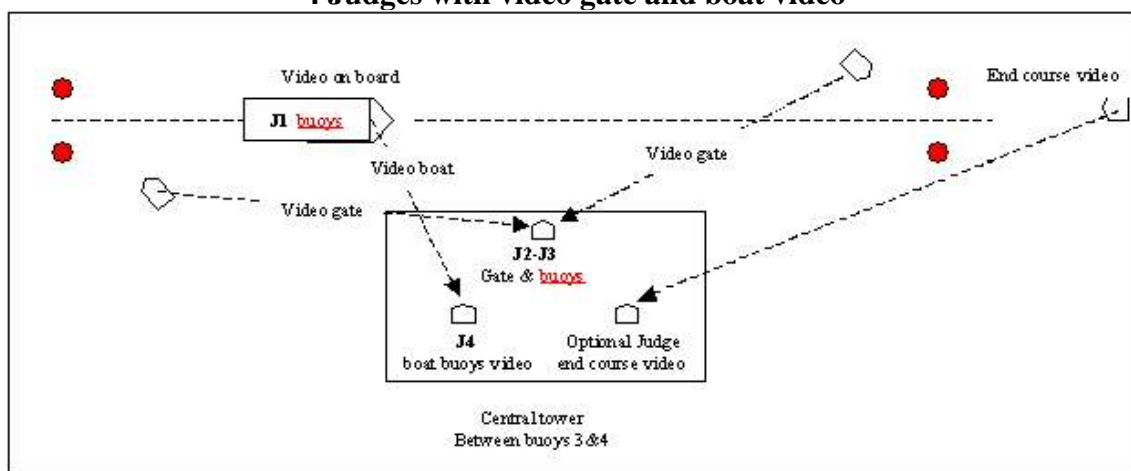

When boat video is used, the boat video will be monitored on the tower by another judge who will advise the Chief Judge if he disagrees with the event judges decision. In which case the Chief Judge and the review judge will again review the tape to determine which score is correct..

If they both agree on a score, that will be the given score. If they disagree or agree that the video does not clearly overrule the score given by the judges, then that score will stand.

If no other Judges are available the Chief Judge may act as boat video review Judge, and if he disagrees with the event judges decision he will ask the Judges to look at the video and the final score will be decided on by simple majority.

If a skier/Team Representative believes that there was an error in a score, he may challenge it by notifying the Chief Judge before the next skier goes out (or as soon as is judged practicable by the Judges) and by putting up **US\$250**. The Chief Judge and a designated review judge will review the video (boat video or gate video). If they both agree on a score, that will be the given score. If they disagree or agree that the video does not clearly overrule the score given by the judges, then that score will stand. The **US\$250** will only be returned if the original score was changed. The boat Judge shall observe the boat path. If any part of the boat deviates outside the bounds of the boat gates, the boat judge shall award an optional reride **with a protected score** if the path of deviation was a disadvantage to the skier. If it was to the skier's advantage, a reride is mandatory.

See also Rule 14.15 End Course Video

14.12: Re Run

If the skier has an imperfect pass, the boat judge shall determine, by appropriate means, whether the skier wishes to take a rerun.

If a rerun is to be taken, the boat shall immediately return through the course in an unscored pass; and the rerun shall then follow in the original direction through the course.

If there are more than two (2) rerides, the skier shall have the option of requesting a five-minute rest before continuing. The rest time will not be allowed to affect the skiing order if it is seeded or in the finals of a major tournament.

14.13: Damaged Equipment

If, between the start dock and the gate buoys on the first pass, a skier notices that his equipment is damaged, the Event Judges may grant him 3 minutes to repair or change the broken equipment and to continue competing. Once a skier has entered the slalom course on the first pass there is no time given to repair damaged equipment unless the skier has damaged his equipment during a run that leads to a re-ride (for example hitting debris or other floating object) he must be back on his skis within 3 minutes from the time the reride has been granted or he is not allowed to continue in the round. If the skier is not able to continue, in the case of a mandatory reride, the pass that brought about the reride is scored to the last good buoy time.

If the skier is not able to continue, in the case of an optional reride (and the skier is not back on his skis within 3 minutes), he is credited with the score obtained in the run that brought about the reride. “

14.14: Safety Equipment

All contestants in Slalom events shall be required to wear an approved life jacket (7.03).

14.15: End Course Video

End-course video shall be recorded for the slalom event for all passes 12m and shorter. A rigidly mounted video camera shall be operated from a point on the centerline on at least one end of the slalom course, adjusted to show all of the boat guides in clear focus, and equipped with optical (not digital) magnification of sufficient power to display the far entrance/exit gate occupying at least 1/6th of the full width of the screen (1/3 width or larger is recommended).

It is recommended that the end course video be monitored from the judges tower and any driving corrections needed communicated to the driver.

A black 5 cm (approx) wide strip up the middle of the windshield will be used to show up on the end course video. If the boat already has a visible center mark on the windshield this is not necessary. A visible mark would be a center seam between two halves of the windshield or a center swing out window that would have vertical seams on either side of center. The mark, if required would only need to come up approximately half way to the top of the windshield, but be clearly visible in the end course video.

The video tape shall be forwarded to the Region Tournament Council for monitoring immediately after the tournament. The Council may cancel results that do not conform to rules 1.11, 14.01, 14.03 and 14.11.

The Chief Judge may assign an end-course judge to monitor the end-course video and award rerides on the following criteria:

If the center of the boat deviates more than 20cm from the center of the course, the end-course judge shall award an optional reride if the path of deviation was a disadvantage to the skier. If it was to the skier's advantage, a reride is mandatory. If it had no effect, a reride will not be awarded. It shall be considered an advantage if the boat deviates outside the 20cm toward the buoy that the skier is attempting to get around thus making it easier for him to get to the buoy. It shall be considered a disadvantage if the boat deviates outside the 20cm away from the buoy that the skier is attempting to get around thus making it harder for him to get to the buoy. It shall be considered no

effect if the deviation happened in a part of the pass where the skier was not in the process of attempting to round a buoy.

A mark or small post on the top of the windshield that is visible in the end-course video camera (both directions) shall be placed 20 cm from the center of the windshield on both sides of the center to aid in the determination of the 20 cm deviation.

The reride will be awarded if the end-course judge and the Chief Judge agree on the determination. The skier's score up to the point of the illegal deviation shall be protected assuming all other rules criteria have been met (time).

14.16: Driver Times

An additional tolerance for times shall be set to ensure that times are as close to actual as possible. Failure to be in tolerance would not result any re-rides for the skier, but the Driver would be warned to bring his times to within the limits or face removal from the boat if these were consistently not achieved. The Boat Judge and Chief Judge will monitor the drivers performance and ability to stay within the drivers tolerance and take appropriate action.

BOAT SPD	Score:	All 6
KPH	Fm/To:	E-X
	Fast	16.04
58	Ideal	16.08
	Slow	16.12
	Fast	16.90
55	Ideal	16.95
	Slow	17.00

Rule 15 - TRICKS

For the boat, see 10.01; for the tow lines see 10.05; for the tolerances see 11.01.

15.01: Entering the Course

A contestant may refuse to enter the trick course by throwing his handle in the air or by being released by the quick release operator by means of a pre-arranged signal before entering the trick course. If, in the opinion of a majority of the Event Judges, this refusal is without acceptable reason, the skier loses the right to that pass. The skier must be ready to ski immediately upon the boat's return.

If the skier's refusal is accepted, the boat must repeat the regular path and once again head for the trick course.

15.02: If a skier falls:

- a) Before the first pass, he loses the right to his first pass. The boat must then pick the skier up and bring him back in the direction of the second pass.
- b) After the first pass and before the second pass he loses the right to continue the round.

If a majority of the Event Judges determine that the skier has fallen deliberately after the end of his 20 second pass, he loses the right to continue the round.

15.03: General

Each contestant shall be allowed two passes through the trick course during which time he may perform as many tricks as he desires.

15.04: Boat Speed

The contestant shall receive his choice of a constant speed through the course for each pass. The boat speed in trick riding, assuming it is held constant from approximately 50 meters before entering the course, is the skier's responsibility.

15.05: The Trick Course

Two buoys approximately **230** meters apart shall establish the approximate area of the beginning of the trick pass from each direction (see Diagram 3). **The boat shall pass either side of the entry buoy at the choice of the skier.** The end of the pass shall be signified by the 20-second time interval only.

15.06: Timing for the Trick pass will start:

Positioning tricks at the start of a pass must be done before the entrance gate.

Any trick completed before the entry gate will be treated as a positional, out of course trick.

Any trick completed after the entry gate will be treated as an in course trick.

After passing the approximate position of the **entry gates** the beginning of the trick pass shall begin:

- a) For a surface trick, at the first discernable rotation of the ski from the tracking direction (or position).
- b) For a wake trick, at the earliest of the following to occur:
 - i. At the first discernable rotation of the ski from the tracking direction (or position) as the skier approaches the wake, or;
 - ii. When the ski under the binding of the leading foot leaves the water surface no longer supporting the weight of the skier, or;
 - iii. When the binding of the leading foot crosses the crest of the wake.
- c. **It is the skiers responsibility to start his pass within 15 metres after the entry gate buoys. Re-rides will not be granted for reasons caused by a skiers late start.**

15.07: The trick pass shall end:

- a) on the sounding of a short, loud audible device 20 seconds after the start of the pass. The 20-second interval shall be timed and indicated by an automatic device (see 11.03).
- b) when the skier falls in course.

15.08: Proceeding through the two trick passes

The boat shall follow as closely as possible the path specified by the Judges for the event, such path to include the preparation time before each pass. The second pass shall be in the opposite direction from the first pass. A skier may not return to pick up a dropped ski. ~~nor add a second ski between passes.~~

If the skier falls during or at the end of the first pass he will receive a maximum of 30 seconds in which to be ready to be taken by the boat for his second pass.

If the skier did not fall during or at the end of the first pass he may ask the boat to be stopped between passes for a maximum of 45 seconds.

In each case the time shall start when the boat gets to the skier.

In each case the skier is allowed to change **or repair** equipment but must be in the water ready to go within the appropriate time frame or he loses the right to his second pass.

Between the start dock and the gate buoys on the first pass, if a skier notices that his equipment is damaged, the Event Judges may grant him 3 minutes to repair or change the broken equipment and to continue competing.

If a skier refuses to enter the course under the provision in Rule 15.01, and he is not ready when the boat returns for him, he shall be considered as having fallen.

15.09: The skier shall set the speed

The skier shall tell the boat driver what speed he desires on each pass, and/or he may use the preparation time to set the speed up to 50m before entering the course.

The skier is allowed to request a speed change after the 50m point (including any time during the run itself) but by doing so must accept the speed given without the right to request a reride for incorrect speed.

The skier must be given the speed setting he asks for before starting the run. If the wrong speed setting is given then that is a reason for a reride provided the skier does not subsequently change the speed.

15.10: Communication with the Judges

Skiers in the Trick event or other persons shall not communicate with the Judges between passes for the purpose of determining whether a trick or tricks attempted in the first pass were scored.

15.11: Officials.

There shall be three or five judges scoring tricks **from the boat video**. Three judges may be used if immediate video review is available at the judge's position. As a variation, two sets of three judges may be used, one set for each pass. The judges selected to call the trick runs shall be the event judges.

Immediate video review shall consist of (for whatever number of judges) ONE immediate replay of the pass at normal speed to allow the judges to check what they have written. Then the sheets are handed in after which any further necessary review resorts to the existing rules.

The World Championships will have five judges. For World Cup and professional events 3 judges are considered sufficient if wished.

It is recommended that 5 judges be used for major tournaments

Skiers should not be kept waiting between passes for video review. It is acceptable to hold the next skier while a video review is carried out of the previous skier, but not between passes.

~~The judges' positions shall be a minimum of 3m above water level. Alternately, the tricks may be judged from an in boat camera video transmitted live to a video monitor. In this case the backup video may be from the shore.~~

~~For L&R tournament scores over 6000 for women and 8500 for men, boat video will be mandatory from 1st November 2006.~~

Each judge shall watch and record the tricks independently. He shall list each trick attempted by the skier and decide with respect to each trick:

- a) if it was performed according to the rules governing that trick; and
- b) if it was started after the beginning or completed before end of the pass.

A Boat Judge **may** ride in the boat to check speeds and observe the boat path. The Chief Judge may designate the boat driver as the Boat Judge in the event that a TV **or Video** camera is operated from the boat. ~~The driver shall be designated as the Boat Judge when the official video is taken from the boat. If the boat judge feels the skier is entitled to a re-ride for any reason he will communicate all the necessary information to the event judges who shall make the decision.~~

A person of the skier's choice may be on board to operate a release mechanism supplied by the competitor who assumes all responsibility for his actions, provided he notifies the starter at the dock, at least three skiers listed on the starting list before his turn, of his wish to use a person of his choice for the purpose of operating a release mechanism.

This release person will be considered a part of the skier's equipment, and any delay created by him will be attributed to the skier for the purposes of Rule 2.05. The skier-supplied release operator will subject the skier to disqualification in the event he interferes vocally or physically with the duties of the boat driver or the Boat Judge.

The skier is fully responsible for any release or malfunction of the device, and no request for re-ride will be granted upon premature or accidental release.

A rope wrapped around the pylon and held by the release person may be used as a release mechanism. No more than approximately 1 meter of rope may extend from the pylon. The rope shall not have knots or splices in the 1 meter section for safety reasons. The release person may not adjust or move the rope in any way to take up slack or allow extra length. **He must hold it in one position or release it.** Using the rope to aid the skier will subject the skier to disqualification.

A skier may accept a tournament-supplied release mechanism. In that case, he takes all responsibility for the device. If the tournament supplied release breaks and is no longer usable the event officials may grant a re-ride.

The skier may place a tournament supplied weight of between 20 - 50 kg in the boat on the floor side to side by the feet of the pin man or behind the engine cover.

If a manufacturer can supply something to enhance the wake and it is the same for all skiers then it can be allowed.

In the case of a ballast tank, Team Managers will need to know in advance which boat, with or without ballast is going to be used. The ballast tank must be either half full, full or empty. It may only be set to half full if there is a gauge or indicator to verify this. The use of this technology must be announced in advance. Some events may be run with ballast and others without.

15.12: Timing the Trick Pass

A video trick timing system shall be used. The timer(s) shall determine the beginning of the trick pass as defined in Rules 15.06, 15.07.

The audible device to signal the end of the pass shall be located in the center of the course. If possible, additional devices should be located at both ends of the course.

An audible signal different from the end of pass signal indicating the start of each pass shall be given by the timer to the judges.

In the event that there is a malfunction and the video or backup video is not captured or the timing cannot be determined from the video, a re-ride is mandatory.

The end of the 20 second pass shall be determined by the video measurement. A start/stop judge shall operate or supervise the operation of the video trick timer. (This may also be the end trick review judge) Depending on the system being used he may or may not work with the timer to signal the start and stop.

The trick review judge shall make a determination of the last trick in time. If the Chief Judge agrees with this determination, it shall be official.

A completed trick shall be judged to have been in time if the part of the ski under the binder is on the water in the last frame picture.

If the Chief Judge disagrees then it is the responsibility of the event judges to determine if the last trick is in time.

Optionally, the Chief judge may assign a second video timing judge in his place, of a different nationality than the first judge in international tournaments. If these two judges disagree, the Chief Judge will resolve the disagreement.

It is recommended that for Record Capability, Cash Prize and World or Region Titled events, two video timing judges be used.

The official appointed to review the video shall be assigned for the whole event/series.

Video Trick timing is mandatory for Record Capability and Ranking List tournaments.

When automatic video timing is being used the use of an audible device is optional.

If a skier/Team Representative believes that there was an error in the timing of a trick pass, he may challenge it by notifying the Chief Judge as soon as is practicable and by putting up US\$250. The Chief Judge and a designated review judge will retime the pass. If they both agree on the timing that will be where the run will end. If they disagree or agree that the video does clearly overrule the original time given by the judges, then the timing will change. The US\$250 will only be returned if the original time was changed.

15.13: Credit for Tricks

- a) To receive credit for any trick the skier must remain in or return to skiing position.
- b) Only tricks listed in the Rules will be scored in a tournament.
- ~~c) A skier shall receive credit for a trick performance only if it is performed in the order as declared on his trick list. Tricks performed not listed or performed in a different order than on the trick list score zero. The order shall not be regarded as broken for the failure to perform a listed trick, the failure of the judges to give credit for a trick performed, or the performance of one or more tricks not listed before resuming the listed sequence. The skier may choose which pass he wishes to perform first.~~
- ~~d) If a skier falls on his first pass, he may choose to repeat it as his second pass. He may also continue from where he fell and progress into the second pass. The two listed passes shall be considered as one continuous list for scoring purposes and must progress in that order for proper scoring.~~

15.14: Tricks at the End of the Pass

- a) A trick not completed before the end of a pass shall not be scored.
- b) A trick completed before the end of a pass shall not be scored if the skier ultimately falls as a result of that trick, even if the fall is after the conclusion of the pass.

15.15: Use of the Video Camera

The tricks shall be filmed by a video camera from the boat. The usual procedure will be to transmit the signal by radio to the judges tower. Backup video will be a stored copy of the video at the camera. Other than as stated in 15.11, the video film may only be shown as an aid to the Event Judges under the following circumstances:

- a) At the request of the Chief Judge or the Chief Calculator if it is not possible for the Calculators to obtain a majority decision as to the trick or tricks performed.

- b) At the request of the Chief Judge or Chief Calculator if it is not possible for the Calculators to obtain a majority decision as to whether or not credit is to be given for a trick.
- c) In circumstances which the Chief Judge regards as exceptional, the Chief Judge may review the tape and ask the applicable Event Judges to look at the run again so that the correct score may be established. ~~the Event Judges may review the tape. This request should not be granted if the intention is to change a Judge's decision under 15.11 (a) and (b).~~
- d) At the request of a judge (and approved by the Chief Judge) the video may be reviewed to establish credit or no credit of a trick or tricks provided the judge(s) states which trick(s) they wish to review. It is not the intention to review the entire run.

The video will only be shown at normal speed.

For judging procedures see 15.11

Recommendation:

It is important that the view of the ski must be as clear as possible. The camera needs to be at a sufficient height to achieve this. The camera should be situated higher than the top of the windscreen to give a clear view of the ski.

15.16: Trick Lists

A list of declared tricks to be attempted by the skier may be required from each entrant in the trick event before the event starts. The Chief Judge and Chief Calculator shall determine the exact time when the list must be submitted for each seed of the elimination rounds and for the final rounds. Corrections may be allowed up to one hour before the seed and the final. The trick list shall be prepared using the official code shown in the table of trick values. Reverse turns must be indicated by an R preceding the official code. In each declared trick pass, any trick, including reverses may be listed more than once and in any position in the list.

The intent of the requiring a list is for professional/cash prize/large spectator type tournaments so that the scores can be calculated quickly and announced. The list is to inform the judges of what tricks the skier intends to. There is no penalty for not following the list.

A contestant who fails to submit a trick list when required shall be disqualified from that trick round. A skier may submit a different trick list for the event finals if he so desires. The declared list shall be made available to the officials at the discretion of the Chief Judge.

15.17: Scoring

The scorers shall receive the tabulations and, in the event of a discrepancy, shall decide the tricks to be scored on the basis of a simple majority from among the judges' individual tabulations as to:

- a) what trick was performed;
- b) if it was performed according to the rules governing that trick; and
- c) if it was started after the beginning or completed before the end of a pass; and
- ~~d) if it was declared by the skier in his submitted trick list according to Rule 15.16.~~

If there is more than one sequence that can be scored, the sequence that gives the maximum points shall be used.

In order to score the basic and reverse of any trick they must both be performed in the same pass.

A maximum of six flips will be scored.

Event placement for skiers qualifying for the final round will be based on their final round results only. The contestant with the highest score shall be the winner.

15.18: Ties

If a tie exists for first place, it shall be run off. If a tie exist for 2nd or 3rd place, placement shall be decided on the basis of the higher preliminary round score. If a tie still exists, it shall be run off. The run off shall have a new drawing for order. Each tying contestant shall be allowed one pass through the trick course until the tie is broken.

15.19: Trick Descriptions and Values

- a) Except in the case of attempted side slide turns, a trick is any activity which occurs between two hesitations. In the case of an attempted side slide, the hesitation in the 90-degree position is to be ignored in applying this rule. Credit may be received for performance of only one trick and the associated reverse, if any, on two skis and one trick and the associated reverse, in any, on one ski under each number in the table. If this rule is violated, only the higher scoring of the repeated tricks shall be scored.

If it is not clear which end of the trick ski is the front (due to binding placement or angle) then the front shall be clearly indicated on the ski. Officials may require the skier to wear an indicator on the front leg (band or ribbon) to assist in this determination.

- b) A wake turn not executed in mid-air and across the crest of the wake scores 0. It is not scored as a water turn.

The ski will edge towards the wake, then the push/pop comes first then the rotation, or the push/pop and rotation come at the same time. The rotation cannot come before the push/pop.

An inadvertent touch of the water with the ski tip during the rotation is acceptable on tricks with 540 degrees or more of rotation.

Definition of a Pre-turn

A pre-turn is a turn off of a flat ski where the push/pop comes after the rotation has started. A wake trick that is pre-turned scores 0.

To receive credit for the wake flip, it is required that both feet be higher than the head and in approximately the same vertical plane at some point during the execution of the trick.

A front wake flip shall be defined as a forward somersault done in the air off the wake in which the tail of the ski passes up and over the head as the head goes down and forward. The rotation must be in the direction of travel. Both feet must be above the head and in approximately the same vertical plane at some point during the execution of the trick.

Sample of a correct rotation **Front Flip** The rope may be held in either hand

Sample of minimally acceptable correct rotation **Front Flip** The rope may be held in either hand The skier is turned slightly and facing the boat but still minimally rotating in the direction of travel which is left to right as viewed from the boat

Sample of incorrect rotation **Front Flip No Credit**

For wake flips with body rotation (#54, #55), the body rotation must be done simultaneously with the flip, not before or after. The WFLIPBFB is not considered a 180 degree turn either for purposes of declared tricks as referenced in Rule 15.16 or for reverse turns as described in 15.19 c). Additionally, for the WFLIPBFB, the reverse must land in the opposite wrap or turn in the opposite direction. Also, specifically for the WFLIPBLB, the stepover portion of the trick must be done simultaneously with the flip and the body rotation.

- * WFLIPB5F and WFLIPB5B must be done hand-to-hand. The rope may not be wrapped around the body to assist the turn. This does not prohibit the simple back position wrap where the rope does not go around the body.

- c) A reverse trick must immediately follow the basic turn in the same pass; however, any type of 180° turn is allowed between two such turns. The reverse shall not be disallowed simply because it follows an attempted trick which has not been credited or because the basic trick is a repeated trick.

Reverse turns under Trick 5 are limited to 360° but may follow a 360°, 540°, or 720°.

Reverse tricks under Trick 12 are limited to 540° but may follow a 540°, or 720°.

On 1 ski and 2 skis only one basic trick and one reverse are allowed under Trick 27 and under Trick 28, but may be any reverse trick listed, i.e., the original may be a WL5, WL5L, or a WL7, and the reverse may be any reverse of any of the above.

The reverse WFLIPB is defined as a WFLIPB leading with the opposite shoulder and traveling in the opposite direction (right to left vs. left to right) from the original WFLIPB, immediately following it. This is identically true for the WFLIPBFB..

- d) Stepmover line tricks are complete only when the free foot touches ski or water or the lifted ski touches water after the turn before the next trick or the end of the pass.

The skier may not put his leg or lifted ski across or on top of the line, the handle, or either arm until he begins to execute the turn. The stepover and turn actions must be simultaneous. Immediately on completion of a FB stepover turn, the skier must have at least one arm between his legs holding the handle.

A wake stepover 360° consists of a 180° wake stepover and a 180° wake combined, in either order, all done in the air, off the wake, in a continuous turn. A wake stepover 540° consists of a 180° wake stepover and a 360° wake combined, in either order, or a 180° wake stepover preceded and followed by a 180° wake combined, all done in the air off the wake in a continuous turn. A wake double stepover 540° consists of a 180° wake stepover and a wake stepover 360° combined, in either order, all done in the air off the wake in a continuous turn.

To complete these trick successfully, either FF, BB, FB, or BF, the skier, when he is in a back position, must have at least one arm between his legs holding on to the tow handle.

A stepover turn not performed according to the rules for a stepover but conforming to the rules for a 180° or 360° surface or wake turn shall be scored as zero.

Toehold stepover tricks must be a simultaneous action. The towing foot may not touch the water during the execution of the trick, except that at the end of the trick after the stepover and turn are complete either the towing foot or the ski may touch down first.

- e) All side slides include a 90° turn from skiing position and a return to the skiing position in the original direction. Whether the side slide is hand-held or toehold, the ski must slide for at least 2m.
- f) In ski line tricks, both feet must be on the ski and pass over the line while in midair. The feet may pass over the line at any point during the execution of the turn. The line must be out of the water during the execution of the turn. This does not include the inadvertent hitting of the rooster tail near the boat.
- g) Once the skier has put the toe strap on his foot, any trick performed in which the foot in the strap intentionally touches the ski during the setup or execution of the trick shall not be scored.
- h) A maximum of 6 flips will be scored for each skier in his turn. Flips are trick numbers 43,44,53-62

Rule 16 – RECORDS

16.01: What Records are recognized

The IWWF shall recognize World records for tricks points, slalom performances, jump distances and overall points for the Men's and Women's divisions. The Regions may, in addition, recognize Region records under the same standards provided for World records. The Regions may, however, recognize records for division other than those recognized by the IWWF. The Region in which a record may be recognized shall be determined by the nationality of the skier rather than the location of the tournament.

As a clarification, the only records kept for Junior skiers are those set at World Championships in those age categories. These records are known as World Junior Championship Records.

16.02: Tournaments where records may be set

Records may be set only at tournaments homologated by the IWWF, a Region, a Federation, or the Tournament Council of the IWWF.

In any one tournament, no more than three rounds are eligible for setting records except that in a tournament where the first round is a preliminary round and the following three rounds are either an 8-4-2 bracket as described in Rule 17 or open rounds with a cut to the next round.

16.03: Jump Records

A jump shall be a new record if it exceeds the current official record. If the distance equals the established record, the skier will become co-holder of the established record.

16.04: Slalom Records

A slalom performance shall be a new record if it exceeds by 1/4 point or more the current official record. If the score is equaled, the skier will become co-holder of the established record.

A slalom performance shall be a new record if it exceeds by 1/4 point or more the current official record. If the score is equaled, the skier will become co-holder of the established record.

16.05: Trick Records

A trick performance shall be a new record if it exceeds the current official record. If the score is equaled, the skier will become co-holder of the established record.

16.05a: Overall Records

Current World Overall Record Event Scores

	Slalom	Trick	Jump	Overall Record
Men - Jaret Llewellyn	5@11.25	10730	71.7	2818.01
Women – Regina Jaquess	4@10.75	7920	53.6	2945.85*

* New Scoring Method 2006 - slalom base reduced by 24

- for a new Men's record, it must be exceeded using the original scoring method and then the new record will be recalculated using the reduced slalom count and listed that way.

An overall performance shall be a new record if it exceeds by 0.01 point or more the current official record. If the score is equaled, the skier will become co-holder of the established record. The scoring will be based on the scores noted in the following chart

Overall Event Record Base Scores

	Slalom	Trick	Jump
Men	1@9.75	11680	67.8
Women	1@10.25	8580	50.5

Use these forms to calculate a potential new record

The online forms are at:

<http://www.iwwfed.com/rules/OverallRecordCalculator.htm>

Men Overall Record Calculator - Current Record 2724.07 (2818.01 old calc method) A men's record must exceed the old calc and then the new calc is used.

Event	Base	Score	
Slalom	1@9.75(49)	<input type="text"/>	
Tricks	11680	<input type="text"/>	
Jump	67.8	<input type="text"/>	
Overall (new)		<input type="text"/>	Overall (old) <input type="text"/>

Women Overall Record Calculator Current Record 2850.11 (already under the new calc method)

Event	Base	Score
Slalom	1@10.25(43)	<input type="text"/>
Tricks	8580	<input type="text"/>
Jump	50.5	<input type="text"/>
Overall		<input type="text"/>

Overall Records may be set in tournaments where there is no overall competition as long as there are distinct rounds of each event and the performances are all in the same round.

~~Overall records may be approved at the tournament under the authority of the Chief Judge and Homologator who shall submit a form attesting to the performances along with the Electronic Homologation Dossier showing that all the requirements for an R tournament were met.~~

For an Overall Record, each discipline is treated as a separate record - with trick review, slalom review and jump review by the applicable event judges on the site. **For the overall record, the three event applications shall be submitted for tournament council approval.**

An overall record cannot be approved until such time as each individual event element is approved if that individual element is in itself a record.

16.06: Ties in a Event

In the event of equal performances in a round of a tournament event, the record shall be co-held no matter which skier may be the ultimate winner of the event.

16.07: Record Forms and Criteria

Specifications of equipment, courses and measuring devices shall be set by the Official IWWF Record Forms, which must be completed and certified by the Region Tournament Council Chairman, by the Chief Judge and other required officials.

These record forms shall require that for a trick or slalom record, the performance must be video taped.

- a) Slalom. **Boat video, Gate video, and end-course video will be per the rules requirements. The event judges will examine the video for compliance to the Rules. The videos will be sent with the record forms to the chairman of the IWWF Tournament Council.**

The video will be examined to verify that the path is within the following deviation specifications:

Maximum deviation of the boat at the guide buoys - 20 cm toward the buoy.

Total cumulative deviation allowed based on score is as follows:

Score	Cumulative Deviation
0.25 - 1.00	20 cm
1.25 - 2.00	28 cm
2.25 - 3.00	35 cm
3.25 - 4.00	40 cm
4.25 - 5.00	45 cm
5.25 - 6.00	49 cm

- b) Tricks. Video will be taken as per Rule 15.15. This video will be viewed in regular speed by the Event Judges for record verification. Although the record verification cannot change the score recorded in the tournament, the score may be changed for the record submission. The video will be sent with the record forms to the chairman of the IWWF Tournament Council. ~~The review of the Chairman and the TC may use slow motion or freeze frame to make sure the record is good.~~ **The Chairman and the TC will use a predetermined process to review the trick runs.**
- c) In jumping, a video jump measurement system is required. Currently there are three approved systems. One system is the photogrammetric based system requiring one camera and grid buoys developed by Bob Corson (USA). Another is the two camera trigonometric system developed by Olaf Boettcher (GER). A three camera trigonometric system developed in Japan was also approved.

The homologator will measure the exact position of the video jump buoys in the video jump buoy course (if used).

A video jump record submission shall include the survey, a copy of the video, a gif formatted file of the record jump, a gif file of the video grid box if in the record jump gif any of the buoys are obscured, and all configuration and setup files appropriate for the system being used to allow independent verification.

All videos submitted on videotape will be VHS. The format that the tape was recorded in will be clearly marked on the tape.

Electronically formatted videos may also be submitted and are preferred. The digital file must be an avi type file. It is important to note that files formatted as DVD movies cannot be accepted as they do not retain exact frame integrity for timing purposes. The files can be submitted via email or on a physical medium such as a CD or DVD.

16.08: Record Administration

- a) World Records may only be set at tournaments sanctioned by the IWWF, a Region, or an affiliated National Federation. In some instances, a Region or Federation may specify specific events as record capability. In this instance, only performances from such specified events shall be considered for World Records.
- b) At tournaments where World Records may be set, the Tournament Homologator shall be responsible for supplying the Chief Judge with the technical information required by the IWWF record application form.
- c) The Chief Judge shall be responsible for the completion of the required application. The completed record form shall be sent by the Chief Judge within one week of the completion of the event to:

the skier's National Federation

the Chairman of the Region Tournament Council where the record was performed

the Chairman of the IWWF Tournament Council

Under no circumstances will a record application be considered unless the appropriate record application forms are completed and all rules conformed to within the stated time limits of one week (7 days).

- d) Upon receipt of the form and the necessary support documentation, the Chairman of the IWWF Tournament Council will either approve or disapprove the application and will advise the IWWF Tournament Council members and the IWWF President of his decision.
- e) The record will then be official, pending final ratification by the Tournament Council.
- f) The Tournament Council must advise the Chairman of their ratification or disapproval of his ruling within 30 days of their receipt of the information.
- g) Records shall be ratified if approved by a two- thirds majority of the Tournament Council. There shall be no proxy voting.
- h) A record can only be approved if the performance was achieved during a sanctioned competition (c.f. 16.02). Record performances achieved during a run-off of a tie are not acceptable.
- i) Should the Tournament Homologator and/or Chief Judge fail in the responsibilities of these duties, sanction shall be determined and levied by the IWWF Executive Board following receipt of a report by the Region Tournament Council Chairman.
- j) In the unusual instance where a potential World Record performance occurred and it was intentionally not applied for as a World Record, the Tournament Homologator, Chief Judge, skier, and Federation may be subject to disciplinary action as determined by the IWWF Tournament Council and the IWWF Executive Board.

Rule 17 - OPTIONAL RULES

17.01: Head-to-Head Competition

Head-to-head competition may be held instead of the regular format detailed in these rules. A preliminary contest for seeding may be held, or seeding may be based on previous performances or the World Rankings.

- a) Rounds. The tournament shall consist of three rounds.
- b) Cutting Procedure. The first round shall consist of eight skiers. The second round shall be cut to four skiers. The third round shall be cut to two skiers.
- c) Pairings. The top eight skiers are paired high score against low score. The skier with the higher score may choose to go out first or second at each pairing. In slalom, all skiers must start at the same predetermined speed and line length (see diagram).
- d) General. In each head-to-head pair, the skier going first shall follow the towboat through the entrance gate in the slalom course, pass around the outside of any or all six buoys at his discretion, and proceed through the exit gate (constituting a pass). The boat shall then stop outside the course and the skier going second in the pair shall make a pass through the course in the same manner behind a second boat. If the first skier has not missed any buoys or gates, he shall re-enter the course from the opposite end, and following the completion of his pass, the second skier, if he has not missed any buoys or gates, shall also re-enter the course from the opposite end. The skiers shall continue in this manner until each of them has either fallen or missed a buoy or a gate. Jump and trick competition may be held in the same manner. Optionally, one boat may be used. In this case, the first skier will ski until he misses or falls. The second skier will then attempt to better the first skier's score.
- e) Placement shall be determined as follows:
The skier with the higher score in each head-to-head pair shall be the winner of that pair. If the skiers tie, the skier who went first shall be declared the pair winner. The contestant winning the pairing in the third round shall be the winner of the event. The other skier in the final pair shall be considered as the second place skier. Optionally, the two losers in the second round may be paired up to determine third place. If this is done, this pairing shall be run off before the final pairing.
- f) Boats. Two alternating boats shall be used in all events. The order shall be determined by the Chief Judge. Optionally, one boat may be used (see d).

HEAD-TO-HEAD COMPETITION PAIRING TREE

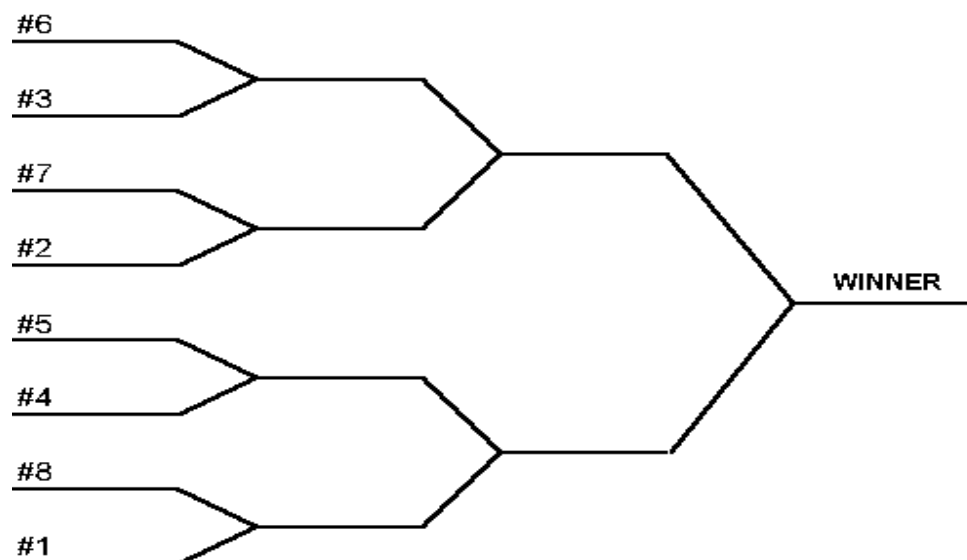

Rule 18 Ski Flying

18.01: Ski Flying general definition and conditions

Ski Flying is intended to be an experimental, promotional event limited to elite skiers and with a limited number of contests sanctioned. All IWWF Rules apply per this rulebook with the following exceptions and modifications as noted below which will supercede the relevant rules as indicated. There will be both men's and women's competition.

18.02: Ski Fly Tow Lines

A contestant may furnish his own line and handle for the ski fly event and it may be of any dimensions or material. The length of the handle attachment measured from the inside surface of the attaching loop furthest from the handle to the center portion of the handle furthest from the attaching loop must be no longer than 32.0m.

18.03: Ski Fly Ramp

- a) The ramp must be parallel to the jump course with a tolerance of +7 degrees open & 5 degrees open.
- b) The surface must be flat with a maximum deviation of 5.0 cm. from a plane as measured in 13.02 f)
- c) The jump ramp should be an inclined plane with an apron on the right hand side. The ramp shall meet the following specifications:
 - o Length out of the water: 7.35-7.50m at all points - (7.45 recommended)
 - o Height of ramp 1.78m (at 7.45m) - as required to meet angle specification
 - o angle 0.239 +/- 0.003

18.04: Ski Fly Pylon Specifications

The height of the pylon will be no higher than 130cm. Ref 10.01 c)

18.05: Ski Fly reference buoys for spectators

Distance buoys may be placed every 3m. Recommended to start at 67m and end at 85m. The buoys are for spectator reference and should be placed so as not to interfere with the jumper.

18.06: Ski Fly boat minimum qualification

A skier must have a certified minimum jump score of 60.8m from an L or R class tournament to qualify for a Ski Flying event.

(2000-1) A female skier must have a certified minimum jump score of 45.0m from an L or R class tournament to qualify for a Ski Flying event.

18.07: Ski Fly boat speeds

- o Speed control will be used
- o The max speed for men is 72 km/h
The max speed for women is 66 km/h
The skier's chosen speed will remain constant in the 82m section.
- o Speed may increase 8 km/h in the 41m section from start speed.
- o Timing charts (note: only the 1st segment is timed)

Speed	fast	actual	slow
57	5.11	5.18	5.25
60	4.86	4.92	4.99
63	4.63	4.69	4.75
66	4.42	4.47	4.53
69	4.23	4.28	4.33
72	4.05	4.10	4.15

18.08: Ski Fly World Records

World Records, if achieved, will be declared as official at the site on the authority of the Homologator and Chief Judge.

SKI FLY JUMP COURSE DIMENSIONS

dimension	range
210m(length)	207.9m-212.1m
210m(off-line)	-.5m to + .5m
82m	81.59m-82.41m
41m	40.795m-41.205m
19m	18.85m-19.15m
23.0m	22.85m-23.15m
10m	9.8m- 10.2m
5m	4.90m-5.10m
4.0m	3.90m-4.10m

SKI FLY JUMP COURSE BUOY COLORS

buoy	color
19st	red
23st	red
19mt	yellow
23mt	yellow
19et	red
23et	red
19ec	yellow
23ec	yellow
210m	green

HOMOLOGATION GUIDELINES

It is the duty of each skier to report to the Chief Judge during the competition if he believes the rules are not being followed or adhered to. The issue will be addressed at the tournament.

1. Slalom

- a) The maximum size acceptable triangle is one with an inscribed circle diameter of 10cm. If the diameter is greater than 10cm, one vertex may be used if it agrees with an alignment sighting.
For L class and lower, a two station survey may be used. A visual check must be made confirming the straightness of the course. This also applies to the jump course.
The centerline is a line from the middle of the entry gates to the middle of the exit gates.
- b) The surveying instrument must have an accuracy of 20 seconds or better.
- c) All skier buoys and end gates must be measured (diameter and height) for record submission.
- d) The ropes should be stretched by use in practice or on land against a fixed object to insure tightness of the splices before measurement. When used in practice, the ropes should be used in rotation to give them equal use.
- e) Personal handles shall be measured by the dock starter under the responsibility of the homologator, immediately before the skier skis. Once the handle is measured it will remain in the custody of the tournament officials until it is used. The Chief Judge may require skier ropes and handles to be re-measured immediately after use. Should the handle be out of tolerance following a skier's return to the dock, then it shall be retained by the tournament officials and retested after at least a one hour relaxation period. If the rope remains out of tolerance after the one hour period, the skier's performance in that round is disqualified.

2. Tricks

- a) A video with a free running clock embedded on the screen with a display of at least .1 second resolution is recommended.
- b) The audio on the Video Camera Recorder shall pick up the sound of the horn.
- c) Tape format is to be VHS **or electronically submitted** as per Rule 16.07.

3. Jump

- a) The jump course shall be checked by survey.
- ~~b) The computer system must be checked against the benchmark.~~
- ~~c) The ramp setup must give proper triangles as described in the benchmark.~~
- ~~d) Protractors should be in degrees with a gradation of .2 degrees. Minimum radius of the protractor shall be 25 cm.~~
- ~~e) The maximum difference of readings between top and bottom stations on a fixed sighting point (on land) shall not exceed .1 degree. This is to be checked at several points through the range and include the other stations.~~
- ~~f) Angles may be called in to .1 degree of accuracy.~~
- ~~g) A recommended check is to sight buoy 15ET for a small triangle and check against actual distance.~~
- h) Personal handles shall be measured by the dock starter under the responsibility of the homologator, immediately before the skier skis. The Chief Judge may require skier ropes and handles to be re-measured immediately after use. Should the handle be out of tolerance following a skier's return to the dock, then it shall be retained by the tournament officials and retested after at least a one hour relaxation period. If the rope remains out of tolerance after the one hour period, the skier's performance in that round is disqualified.
- i) Two test buoys must be placed at approximately 40m and 60m jump distances and their exact location as measured by survey and by the video jump system must be recorded on the dossier. The buoys must be independent of the video jump system (i.e. not used as reference buoys by the system).

- j) The jump ramp must be waxed. The wax used must have been previously used and tested and found to be appropriate for the use.

4. Dossier

The Electronic Dossier checklist shall be submitted within 14 days by uploading it to www.iwwfed.com via the Submit Homologation Dossier function.

5. Speed Control

Calibration should take place before the competition starts or the skiers arrive.

The homologation notice will state the make and model of the speed control and if specific features/settings are to be used (i.e. for Perfect Pass whether wakeboard or trick mode will be used for the trick event).

TRICK VALUE CHART

WATER TURNS

				2 SKIS		1 SKI	
CODE		DESCRIPTION	NO.	BAS	REV	BAS	REV
S		Side Slide	1	20	20	40	40
TS		Toehold side slide	2	-	-	130	130
B	180	F-B	3	30	30	60	60
F		B-F	4	30	30	60	60
0	360	F-F	5	40	40	90	90
BB		B-B		40	40	90	90
5B	540	F-B		50	-	110	-
5F		B-F		50	-	110	-
7F	720	F-F		60	-	130	-
7B		B-B		60	-	130	-
LB	180	F-B Steptover	6	70	70	110	-
LF		B-F Steptover	7	70	70	110	-
TB	180	F-B Toehold	8	-	-	100	100
TF		B-F Toehold	9	-	-	100	100
TO	360	F-F Toehold	10	-	-	200	200
TBB		B-B Toehold	11	-	-	200	200
T5B	540	F-B Toehold	12	-	-	350	350
T7F	720	F-F Toehold		-	-	450	-
T5F	540	B-F Toehold	13	-	-	350	-

WAKE TURNS

				2 SKIS		1 SKI	
CODE		DESCRIPTION	NO.	BAS	REV	BAS	REV
WB	180	F-B	14	50	50	80	80
WF		B-F	15	50	50	80	80
WO	360	F-F	16	110	110	150	150
WBB		B-B	17	110	110	150	150
W5B	540	F-B	18	310	310	310	310
W5F		B-F	19	310	310	310	310
W7F	720	F-F	20	800	800	800	800
W7B		B-B	21	480	480	480	480
W9B	900	F-B	22	850	850	850	850
W9F		B-F		850	850	850	850
WLB	180	F-B Stepover	23	110	110	160	-
WLF		B-F Stepover	24	110	110	160	-
WLO	360	F-F Stepover	25	200	200	260	260
WLBB		B-B Stepover	26	200	200	260	260
WL5B	540	F-B Stepover	27	300	300	420	420
WL5LB		F-B Double Stepover		-	-	500	500
WL7F	720	F-F Stepover	27a	700	700	700	700
WL9B	900	F-B Stepover	27b	800	800	800	800
WL5F	540	B-F Stepover	28	300	300	420	420
WL5LF		B-F Double Stepover		-	-	500	500
WL7B	720	B-B Stepover		550	550	550	550
WL9F	900	B-F Stepover	28a	800	800	800	800
TWB	180	F-B Toehold	29	-	-	150	150
TWF		B-F Toehold	30	-	-	150	150
TWO	360	F-F Toehold	31	-	-	300	300
TWBB		B-B Toehold	32	-	-	330	330
TW5B	540	F-B Toehold	33	-	-	500	500
TW5F		B-F Toehold	34	-	-	500	-
TW7F	720	F-F Toehold	35	-	-	650	650
TW7B		B-B Toehold	36	-	-	650	-
TWLB	180	F-B Toehold Stepover	37	-	-	320	-
TWLF		B-F Toehold Stepover	38	-	-	380	-
TWLO	360	F-F Toehold Stepover	39	-	-	480	480
TWLBB		B-B Toehold Stepover	40	-	-	480	480
TWL5B	540	F-B Toehold Stepover	41	-	-	600	600
TWL5F		B-F Toehold Stepover	42	-	-	700	-
TWL7F	720	F-F Toehold Stepover	42a			800	-
FFL/WFLIPF		Forward Somersault	43	800	-	800	-
BFL/WFLIPB		Backward Somersault	44	500	500	500	500
SLB		F-B Ski Line	45	-	-	350	350
SLF		B-F Ski Line	46	-	-	400	400
SLO	360	F-F Ski Line	47	-	-	400	400

SLBB		B-B Ski Line	48	-	-	450	450
SL5B	540	F-B Ski Line	49	-	-	550	550
SL5F		B-F Ski Line	50	-	-	550	550
SL7B	720	B-B Ski Line	51	-	-	750	750
SL7F	720	F-F Ski Line	52	-	-	800	800
DBFL/WDFLIPB		Wake Double Flip	53	1000	-	1000	-
BFLO/WFLIPBFT		Wake Flip Full Twist	54	800	-	800	800
BFLBB/WFLIPBBBT		Flip Full Twist BB	56	800	-	800	800
BFLB/WFLIPBFB		Wake Flip Half Twist B	55	750	750	750	750
BFLF/WFLIPBBF		Wake Flip Half Twist F	57	-	-	550	550
BFLB/WFLIPBLB		Wake Flip Twist Line Back	58	800	800	800	800
BFL5F/WFLIPB5F*		Wake Flip 5F	59	-	-	850	850
BFL5B/WFLIPB5B*		Wake Flip 5B	60	-	-	900	900
FFLB/WFLIPFB		Forward Somersault with 180 Back	61	850		850	
FFLF		180 Front and a Forward Somersault	62	850		850	
FFLBB		Forward Somersault with 360 B-B	63	900		900	
BFLSLBB		Wake Flip Full Twist B-LB	64	900		900	

* WFLIPB5F and WFLIPB5B must be done hand-to-hand. The rope may not be wrapped around the body to assist the turn. This does not prohibit the simple back position wrap where the rope does not go around the body.

The following substitutions will be allowed on declared trick runs:

- A reverse turn may be indicated by the letter "R" alone
- SS may be used for S in trick numbers 1&2
- OB may be used for BB in all tricks where it is normally used (#5, 11, 17, 26, 32, 40, 48)
- T5B may be used to indicate a RT5B when it immediately follows a T7F
- An R for reverse turns may precede or follow the trick code
- The following variations will be allowed.

WTS for TS or RTS in #2

T7 for T7F in #12

OB or OBB for BB in #'s 5,11,17,26,32,40,51

BB for B in #'s 21,36 & 54 (T7B,TW7B,SL7B)

FLP or FL or FP for FLIP in tricks 43-47

any transposition of the letters WTB/WTF and WBflip

New primary codes are shown for all flip tricks (43-44, 53-60) - the old codes will still be acceptable

In addition to these changes and variations specifically mentioned, it is further noted that the scorer may reasonably interpret the skiers submitted list as to what he actually did as opposed to what he submitted in his written list. The principle is not to give the skier the advantage of not having to write down what his run was, but to allow for mistakes in writing down the trick codes and allowing for perhaps unforeseen variations of the trick codes without unduly penalizing the skier.

ADDITIONAL RULES

IWWF Record Capability and Ranking List Tournament Standards

	World Record	Ranking List
Prior Announcement	YES	YES
Region Approved Panel	YES	YES
Number of Rounds	4	4
Conflict of Interest Rules	Refer to *4	Refer to *4
Chief Judge	1st Class	1st Class
Homologator	Highest Rating	Highest Rating
Calculator	Region Standard*1	Region Standard*1
Driver	top 2 ratings	top 2 ratings
SLALOM		
Course Check	SURVEY*2	SURVEY*2
Slalom Course	No single center line floating courses except of approved design*3	no single center line floating courses except of approved design*3
Tolerances	Per Rule Book	Per Rule Book
Buoys	Measured	Measured
Timing	Automatic	Automatic
End Course Video	Required	Required
Video method	minimum 1/6th screen width of end buoys, 1/3 recommended-one end only	Region Standard*1
Boat Video	Required	Not Required
Gate Video	Required	Not Required
Judging Towers	both sides perfect sight	both sides perfect sight
Judges	5 1st class or 3 1st class	3 1st class/ 2 2nd class minimum or 2 1st class/ 1 2nd class
Backup timer	Not Applicable	Not Applicable
TRICKS		
Course Check	Visual	Visual
Tolerances	Per Rule Book	Per Rule Book
Timing	Video Timing	Video Timing
Video	YES	YES
Judges	5 1st class or, if immediate review is available, 3 1st class - See Rule 15.11	3 1st class/ 2 2nd class minimum or, if immediate review is available, 2 1st class/1 2nd class minimum - See Rule 15.11
Timer	top 2 ratings	top 2 ratings
Boat Judge	Region Standard*	Region Standard*
JUMP		
Course Check	SURVEY*2	SURVEY*2
Tolerances	Per Rule Book	Per Rule Book
Timing	Automatic	Automatic
Protractors	Not Applicable	Not Applicable
Difference on a fixed point	Not Applicable	Not Applicable

Video Jump Measurement	Required	Required
Distance Calculation	COMPUTER	COMPUTER
Program Check	YES	YES
Judges	3 1st Class	2 1st Class/ 1 2nd Class minimum
Video Judges	1st Class	1 1st Class/ 1 2nd Class minimum
Backup Timer	Not Applicable	Not Applicable
Speed Control	Required*5	Required*5
Homologation Dossier	IWWF Electronic Dossier Required	IWWF Electronic Dossier Required

*1 The Tournament Council of each of the three geographic Regions of the IWWF will set the standard to be used in that Region.

All R or L class tournaments must meet or exceed the standards of the IWWF rule book.

*2 Two meter surveys are allowed for class L and lower. A 3 meter survey or a 1 meter with laser range finder survey are the only acceptable methods for R tournaments. For a 1 meter survey, angle only spot checks from a second position are recommended.

*3 For a single center line course to be used, the buoy support structure must be rigid. The buoy support structure is independent of the cable, but attached to it. The structure must guarantee that the line of the three buoys is perpendicular to the wire. The center cable must be taut to assure a straight line. Please refer to additional material detailing this design in Diagram 8.

*4 No conflict of interest allowed for Cash Prize tournaments. For L and R no conflict of interest is allowed unless it is not possible to run the tournament according to the rules. (i.e. no properly qualified official available without a conflict of interest)

Official's Conflict of Interest:

Conflicts of interest, as defined by the following:

(1) An official for an event shall have no conflict of interest with respect to any skier competing in that event. For this purpose "official" shall include boat drivers, event judges, scorers and all secondary positions.

(2) At least one-half of the Appointed Judges shall have no conflict of interest with any skier competing in the event. If a conflict of interest exists, the appointed official so affected shall not rule.

A conflict of interest shall be regarded as existing if the official is:

(1) A member of the immediate family of a contestant, to include lineal descendants and ancestors, brothers, sisters, and spouses of the contestant or any of the above family members.

(2) In a position which may give the appearance of a lack of independence. These conflicts shall be determined by the Chief Judge with respect to event officials and by the Appointed Judges with respect to the Chief Judge and other appointed officials.

*5 For 1999 speed control is required for all L and R tournaments.

Maximum Scores with no Speed Control

Category	Slalom	Figures	Jump	Overall
Men	3 buoys @58/10.75m	8500 points	61 m	2200 points
Women	6 buoys @ 55/12m	6000 points	40 m	2100 points
Junior Men	3 buoys @ 58/12m	5000 points	41 m	1500 points
Junior Women	3 buoys @ 55/13m	4400 points	32 m	1500 points

JUNIOR COMPETITION RULES

JUNIOR WORLD CUP and JUNIOR WORLD CHAMPIONSHIPS RULES

1. Skiers who may participate

- a) Each Federation may send up to four skiers. Of these four skiers, a maximum of three of either sex is allowed.
- b) The maximum age of any skier participating is 16 years as of December 31 preceding the tournament. This means that the last year of eligibility of a skier is the year in which he has his 17th birthday. Specifically, this means that for the tournament in 1998, anyone born in 1981 or later is eligible.
- c) Each skier participating must hold a valid rating card (no older than 1 year) showing these minimum results in the event in which he or she participates:

	Slalom	Tricks	Jump
Boys	6@55 kpH	2500	30 m
Girls	6@52 kpH	2000	20 m

2. Technical Rules

The technical rules shall be identical to those in the most current IWWF Technical Rules with the exception of age and qualification restrictions as stated above and the modifications to the Technical Rules as stated below:

It is generally understood that any reference to the World Championships shall be applicable to this tournament if appropriate.

Drug testing is specifically allowed for junior competitions

- 1.02 The World Junior Championships shall be held biennially in even numbered years.
- 2.05 The tournament deadlines shall be set by the organizer with approval of the Chairman of the IWWF Tournament Council.
- 4.01 item 2 **Skiers not selected for their national teams may qualify to compete in the Junior World Championships if they are ranked on the IWWF Junior World Rankings List in the top eight (8) girls and ten (10) boys in any event and the top five (5) girls and boys in overall.**
- 4.07 Each Federation shall be entitled to enter two skiers whether qualified or not. Such a skier who is not qualified may only compete in two events. In addition, the Federation organizing the World Junior Championships shall be entitled to enter four skiers, whether qualified or not.
- 5.01 Slalom
(Skier's score) X 1000)/(Best score)
Jump
Boys (Skier's score - 20) X 1000/(Best Score - 20)
Girls (Skier's score - 13) X 1000/(Best Score - 13)
- 5.04 There will be no overall final
- 5.05 Team title is calculated as described.
- 6.02 Number of officials at the World Juniors
World Juniors officials 7 judges, 2 from each region with 7th being named by TC Chair from the alternate nominations.
A Chief Driver and 2 other boat drivers will be appointed by the TC Chairman
- 13.01 Girls shall use the 1.5 m ramp. Boys shall use the 1.5 m ramp unless they can show a certified result of a jump of 38m on a 1.5 m ramp in which case they may opt to jump on a 1.65 m ramp.
- 13.03 All skiers shall have the option of boat speed up to a maximum of 51 kpH.

- 13.05 Three jumps are allowed in the preliminary round as well as the final round.
- 14.07 The 1st pass for the Boy's division will be at 55kPH/18.25m. It will then proceed to 58kPH as shown in Rule 14.07. The 1st pass for Girls division will be at 52kPH/18.25m and then proceed to 55kPH as shown in Rule 14.07. The Boy's and Girl's final shall start at 58kPH/18.25m and 55kPH/18.25m respectively.
- 14.11 In the Boys' and Girls' finals, each contestant shall be required to waive at least one pass and six points shall be added to the contestant's score for each pass he elects to waive as well as the one he was required to waive, provided the first pass is perfect.
16. This Rule does not apply.

IWWF Under 21 Division World Championships

1. Skiers who may participate

- a) Each Federation may send up to four skiers. Of these four skiers, a maximum of three of either sex is allowed.

Skiers not selected for their national teams may qualify to compete in the U21 World Championships if they are ranked on the IWWF World Rankings List in the top eight (8) ladies and ten (10) men in any event and the top five (5) ladies and men in overall.

- b) The maximum age of any skier participating is 20 years as of December 31 preceding the tournament. This means that the last year of eligibility of a skier is the year in which he has his 21st birthday. Specifically, this means that for the tournament in 2005, anyone born in 1984 or later is eligible. The year of birth is the year of the tournament -21. Please note that the World Championships in 2003 are under the special provision that qualifying year of birth is 1981 as the rules in different regions have different qualifying ages and this is meant to allow for that and allow the regions to adjust their rules for future tournaments.
- c) Each skier participating must hold a valid rating card (no older than 1 year) showing these minimum results in the event in which he or she participates:

	Slalom	Tricks	Jump
Men	6@55 kPH	2500	30 m
Women	6@52 kPH	2000	20 m

2. Technical Rules

The technical rules shall be identical to those in the most current IWWF Technical Rules with the exception of age and qualification restrictions as stated above.

It is generally understood that any reference to the World Championships shall be applicable to this tournament if appropriate.

5.04 There will be no overall final

14.07 **Finals start speeds – Men 14.25m – Women 16m**

IWWF 35+, 45+, and 55+ DIVISIONS RULES

(Reference Information)

There are three Divisions as follows:

35+ ages 35 to 44

45+ ages 45 to 54

55+ ages 55 and up

The technical rules are as follows:

Division	Slalom	Jump (all at 1.5 m except as noted)	
	start	max	max
35+ Men *	55	55	57
45+ Men	52	55	54
55+ Men	46	55	51
35+ Women	52	55	51
45+ Women	49	55	48
55+ Women	43	52	48

*The **35+ Men** division competitors may optionally select a 1.65m ramp height.

Overall Scoring

Scores shall be determined as per Rule 5.01 with the exception of the following change in the jump formula:

Men

$1000 \times (\text{Skier's score} - 20) / (\text{Best score} - 20)$

Women

$1000 \times (\text{Skier's score} - 14) / (\text{Best score} - 14)$

For slalom scoring the formula will be as follows: $1000 \times (\text{Skier's score}) / (\text{Best score})$

Buoy offsets in slalom for each division

IWWF 35+ Division World Championships

There will be a World Championships for the seniors divisions, 35+, 45+, and 55+.

The specific rules will be circulated separately.

WORLD CUP RULES

World Cup Rules will be approved by the World Cup Committee and published prior to the start of the World Cup season

WORLD RANKING LIST DESCRIPTION AND SCHEDULE

The World Ranking List is a list of the best men and women skiers in each event ranked by performance. A Junior Ranking List is also produced for skiers meeting the Junior age criteria and based on skiing under junior rules. An Under 21 Ranking List is also produced for skiers meeting the Under 21 age criteria and based on skiing under open rules. **35+, 45+, and 55+ lists are also produced for skiers meeting the age criteria and based on skiing the appropriate age division rules.** The ranking is based on the average of each skiers' two best scores from two separate tournaments and two separate sites. Only one score in each event is considered from each tournament. Each IWWF Federation sanctions Record Capability or World Standings List tournaments from which the performances are taken. Performances are taken from score books and submitted by the sanctioning Federation or Region. Any trick score over **11,000** points must be performed in an R tournament to be qualified for the Ranking List. If a skier records only one qualifying performance, he/she will not be eligible for the list. Ties on the ranking list will be broken by taking the highest score first to break the tie, then backed up by the second score, then the third score and so on.

If a performance in an L tournament exceeds the current World Record, it will be placed on the ranking list as one increment below the current record. If a record score is made in an R tournament, but is subsequently rejected then the corrected score shall be used.

A separate ranking list overall will be calculated on the basis of fixed scores in each event on a tournament by tournament basis. This means that an overall score can only be achieved for the list by having an overall performance at a tournament. Event scores from multiple tournaments will not be combined to calculate an overall score. An overall score shall be from a single round of a tournament. The rounds of a tournament shall be set by the organizers and are NOT based on the first time a skier skis in a multi round tournament.

Ranking List Overall Event Score Basis

	Open, Junior, U21	Open, Junior, U21
Slalom	1@9.75/58(73)	1@10.25/55(67)
Trick	11680	8580
Jump	67.8	50.5

The 35+, 45+, and 55+ divisions basis is as specified in the 35+ World Championship Rules.

The maximum number of rounds which can count for the rankings list or records is limited to 3 (except head to head) at any one competition - meaning consecutive days at the same site.

To be eligible to be on the ranking list, a tournament must post the IWWF Homologation Dossier within 30 days of the tournament. This will be done by accessing the following link and downloading the dossier:

<http://www.iwstournament.com/homologation/UploadDossiers.htm>

To be eligible to be on the ranking list, a tournament must post the results within 30 days of the tournament. This will be done by accessing the following link and downloading the results (as placed lists or a scorebook):

<http://www.iwstournament.com/homologation/UploadScorebooks.htm>

SCHEDULE AND SUBMISSION PROCESS

October 31

This is the closing date of the list. Only performances on or before this date are accepted in the current year's listing.

December 31.

Each Federation is sent a listing containing all performances by that Federation's skiers. The Federation must verify all these performances and submit any corrections with appropriate documentation.

February 28

This is the closing date for any final corrections.

March 15

The finalized list is published and distributed.

April 30

A second list will be published using this as a last performance date.

May 30**Final publication of the April list.**

Scores shall be submitted electronically in the following format:

Please note that one record is to be submitted for each performance so that a three event skier skiing in a two round tournament will have 6 records in the shown format.

Scores not submitted in the correct format or missing information will be rejected and returned to the Organising Federation to correct and resubmit.

Data format for individual performance records

Field	Field Name	Type	Width	Dec.	Notes
1	LAST	Character	20		IN CAPITAL LETTERS
2	FIRST	Character	20		In normal mode (John Michael)
3	SKIER	Character	11		Federation specific ID Number
4	GROUP	Character	1		1,2, or 3
5	COUNTRY	Character	3		Normal IOC code
6	SEX	Character	1		M or F
7	TOUR	Character	8		alphanumeric code usually year+country code+number 09FRA015
8	SL	Numeric	5	2	number of buoys only at max speed minimum 30 ex: 42.25
9	TR	Numeric	5		
10	JU	Numeric	5	1	in meters (decimal point separator 56.2)
11	ALT_SCORE	Numeric	7	2	If a slalom score, buoys of last pass If a jump score, optional use distance in feet If a trick score, blank
12	YOB	Character	4		Change to full 4 digit year
13	CLASS	Character	1		R or L for ranking list perfor.
14	ROUND	Character	2		
15	DIV	Character	12		division (local division - must be the same across events for overall calc)
16	PERF_QUAL1	Numeric	6	3	if slalom then line length (14.25,13.00,etc.) if jump then ramp angle (.235,.255,.271 only)
17	PERF_QUAL2	Numeric	2		speed for slalom and jump only
18	DATE	Date	8		date of performance (YYYYMMDD)
19	SPECIAL	Character	1		J if performance done under Junior Rules F if performance is Ski Flying
20	SPEED_CTRL	Character	1		Y=Yes, N or blank=no
21	SL_MISS	Character	1		* means 1st pass not complete (optional if score is already adjusted)

22	PLACE	Numeric	3	0	Placement in the event - use the final placement in each performance record so if the skier placed 2 nd and the tournament was 3 rounds each round record will indicate 2 nd place. Also, the placement is for the division the skier skied in so that a tournament will have a corresponding set of placements for each division.
23	IWWF	Character	12		IWWF License number assigned by the IWWF to each skier
24	Site ID	Character	8		Site Code Country Code followed by a 4 digit number indicating the specific ski site. Multi-lake sites will be given one site code.

** Total **

148

Additional fields for local meaning may be added here such as Club, or State, or League.

Sample text inputs

**HINMAN;Dana;USA1234;;USA;M;98S056R;46.50;;;4.50;1980;R;1;IB;13.00;58;19980524;;Y
;;3;USAM80123459;USA0001**

**HINMAN;Dana;USA1234;;USA;M;98S056R;;4100;;;1980;R;1;IB;;;19980524;;Y;;10;USAM8
0123459;USA0001**

**HINMAN;Dana;USA1234;;USA;M;98S056R;;;52.8;173.0;1980;R;1;IB;0.255;51;19980524;;Y
;;1;USAM80123459;USA0001**

Round 1 shown all three events with a ; delimiter

Data Record Changes

Division field increased to 12 characters

IWWF License Number Field added

Site ID field added

YOB changed to 4 characters as full year example: 1980

The ID number, if not implemented, should be left blank. However, all Federations are an ID number as soon as feasible.

Year of Birth is mandatory.

Special Condition Code now has two cases and they are

1. J if the skier is of junior age and the event was run with junior rules
2. F if the event is Ski Flying

Ranking Lists are currently published two times a year for results less than one year old on the following dates: April 30 and October 31.

The normal procedure will be that performances are submitted any time up to 30 days after the results closing dates (listed above). A preliminary list will then be published. Certified changes may be submitted for 30 days after the publication of the preliminary list. At that point, results will be closed and a final list shall be published.

All data must be submitted through a verification process. It is the responsibility of the submitting authority to ensure that the data is valid. Tournament data will not be accepted until all the tournament data is valid. This process is done by submitting the data at the following address:

<http://www.iwsftournament.com/homologation/IWWF RankingScoresUpload.php>

The lists shall be published on the World Wide Web at the IWWF Home Page

<http://www.iwwfed.com/>

If you do not have access to this method of publication, contact your federation or region administrator for a copy of the preliminary or final list.

DIAGRAM 1 - OFFICIAL SLALOM COURSE

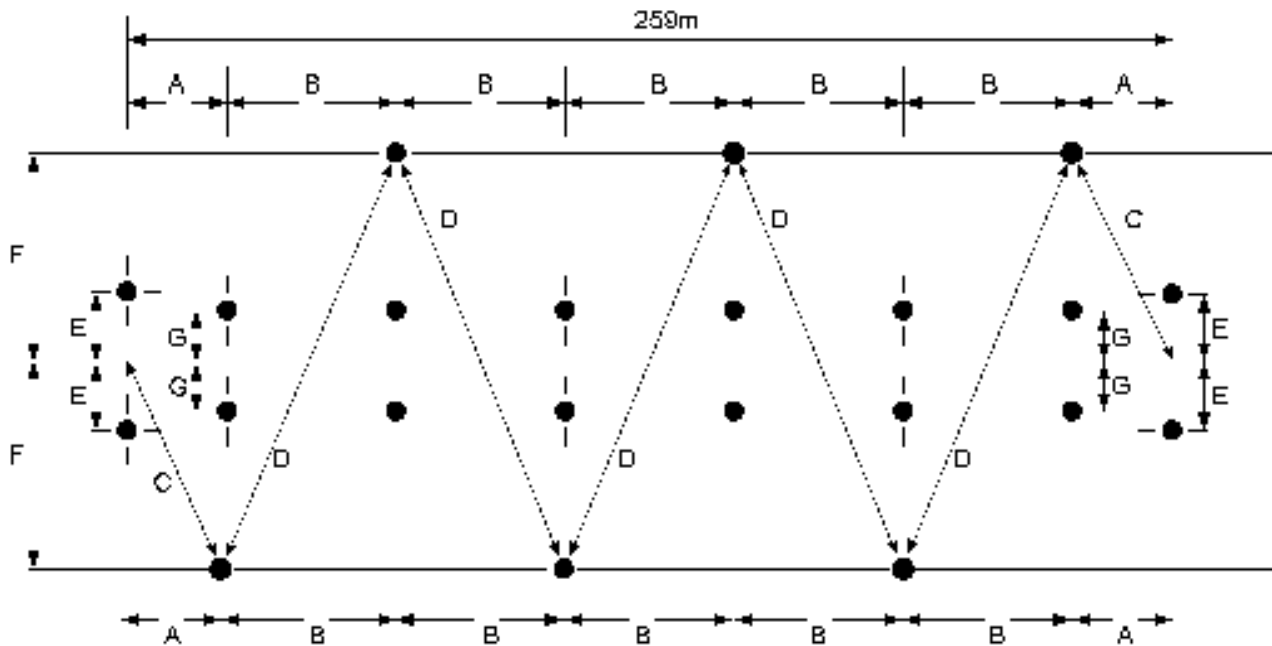

Dimensions	Range	Tolerance
Overall = 259m	258.353-259.648	1/4%
A = 27m	26.865-27.135	1/2%
B = 41m	40.795-41.205	1/2%
C = 29.347m	29.200-29.494	1/2%
D = 47.011m	46.776-47.246	1/2%
E = 1.25m	1.188-1.313	5%
F = 11.5m	11.385-11.615	1%
G = 1.15m	1.035-1.265	10%

Note: The average of the six measured F dimensions cannot be less than 11.48 m.

Buoy colors as follows:

End Gates Red Skier Buoys – Red Boat Guide buoys - Yellow

Timing Buoys - Color other than red or yellow, green recommended (Timing buoys are the buoys at the gate of the 3rd buoy on the timer side of the boat (left) in the direction of travel of the boat).

From both ends of the slalom course, the boat timing buoy which is at the level of the third skier buoy shall be located within +/- 11.5 cm of a position which is 109/259-ths of the actual distance between the entrance and exit gate buoys on that side of the course.

Boat path alignment gates of colors contrasting to the skier and boat gate buoys (green recommended), shall be placed outside the official course at a distance of 55m before the entrance gates at either end and at the 1.15m width of the interior boat guide buoys.

Tolerance:

length 55.00 m +/- 0.275m width 1.15 m +/- 0.115m

Also, as an option, a boat turn buoy may be placed at a distance from 140-180m in line with the course centerline.

These options are shown in Diagram - 5.

DIAGRAM 2 - OFFICIAL JUMP COURSE

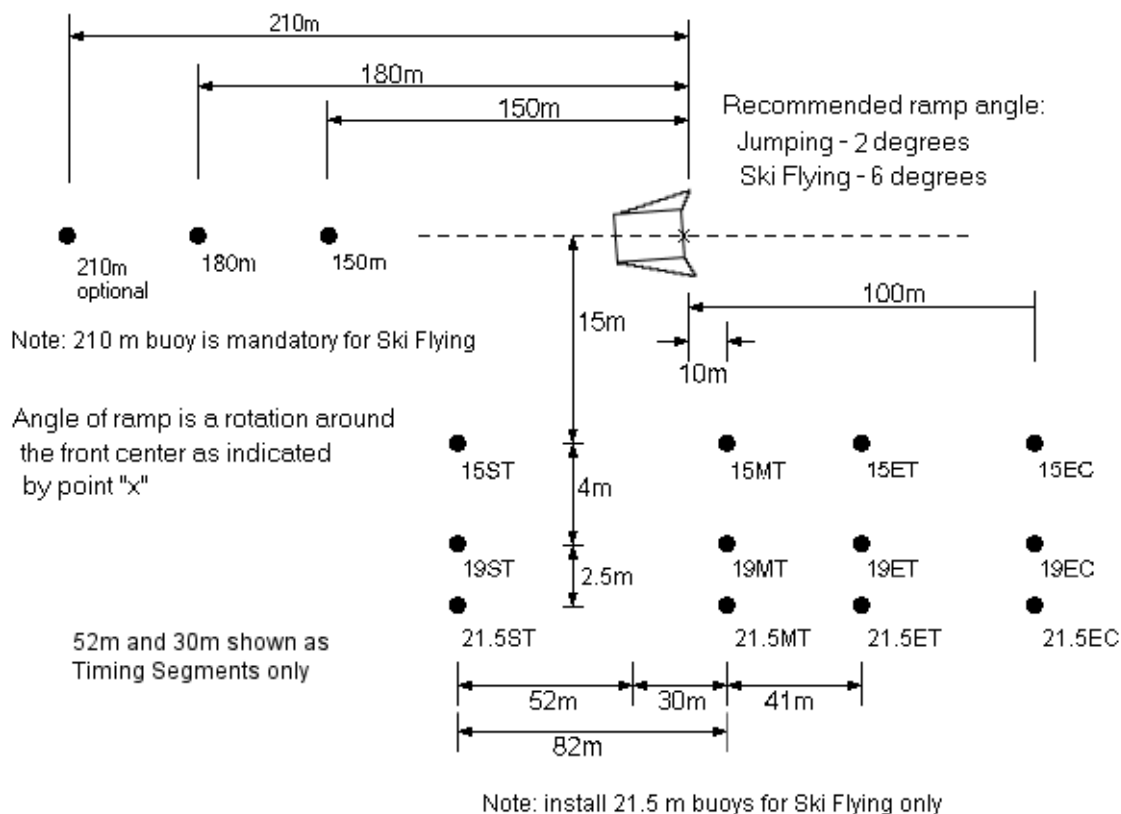

The ramp must be parallel to the jump course and slightly open. The tolerance for standard jumping is between $+1.00^\circ$ and $+2.50^\circ$ open.

The tolerance for ski flying is between $+5.00^\circ$ and $+7.00^\circ$ open.

Open means that the low end of the ramp is turned toward the jump course. The basis of the jump course is the 15ST - 15MT line.

JUMP COURSE DIMENSIONS AND TOLERANCES

A buoy is **recommended to** be placed at 210m from the jump in line with the 150m and 180m buoy. The color will be green.

Dimension	Range	Tolerance
210m (length)	207.9m-212.1m	1%
210m (off-line)	-.5m to +.5m	0.5m
180m (length)	178.2m-181.8m	1%
180m (off-line)	-.5m to +.5m	0.5m
150m (length)	148.5m-151.5m	1%
150m (off-line)	-.5m to +.5m	0.5m
100m	90M-102m	+2%,-10%
82m*	81.59m-82.41m	0.5%
41m	40.795m-41.205m	0.5%
15m	14.85m-15.15m	1%
4m	3.90m-4.10m	2.5%
10m	9.8m-10.2m	2%

BUOY	COLOR
210M	GREEN
180M	RED
150M	YELLOW
15ST	RED
19ST	RED
15MT	YELLOW
19MT	YELLOW
15ET	RED
19ET	RED
15EC	YELLOW
19EC	YELLOW

*Timed as 2 segments, 52m and 30m when required

DIAGRAM 3 - OFFICIAL TRICK COURSE

The following diagram shows the placement of an optional turn buoy and an optional 50 m pre-start buoy as well as the official trick course. It is highly recommended that the optional buoys be used. **For safety, it is recommended that no solid obstruction e.g. jump ramp, dock be within approximately 20m. Other buoys within approximately 10m should be removed or submerged.**

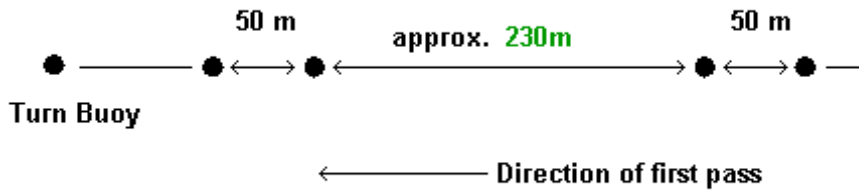

DIAGRAM 4 - OPTIONAL JUMP COURSE TURN BUOY AND GUIDE BUOYS

The following diagram shows the placement of an optional turn buoy and optional boat guide buoys for the official jump course shown in Diagram 2. It is highly recommended that the optional buoys be used.

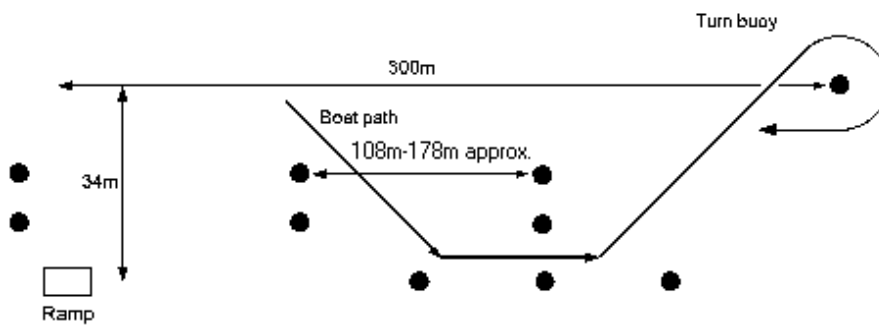

DIAGRAM 5 - OPTIONAL SLALOM COURSE TURN BUOY AND PRE-GATES.

The following diagram shows the placement of an optional turn buoy and optional pre-gates for the official slalom course shown in Diagram 1. It is highly recommended that the optional turn buoys and Pre-Gates be used.

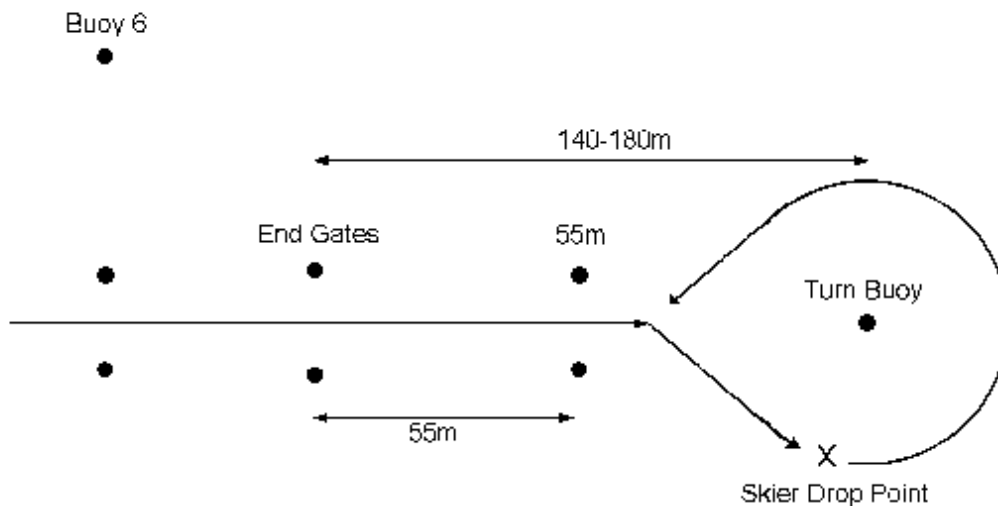

DIAGRAM 6 - SLALOM JUDGING TOWER PLACEMENT

The following diagram shows the placement of the judges' towers for the official slalom course shown in Diagram 1.

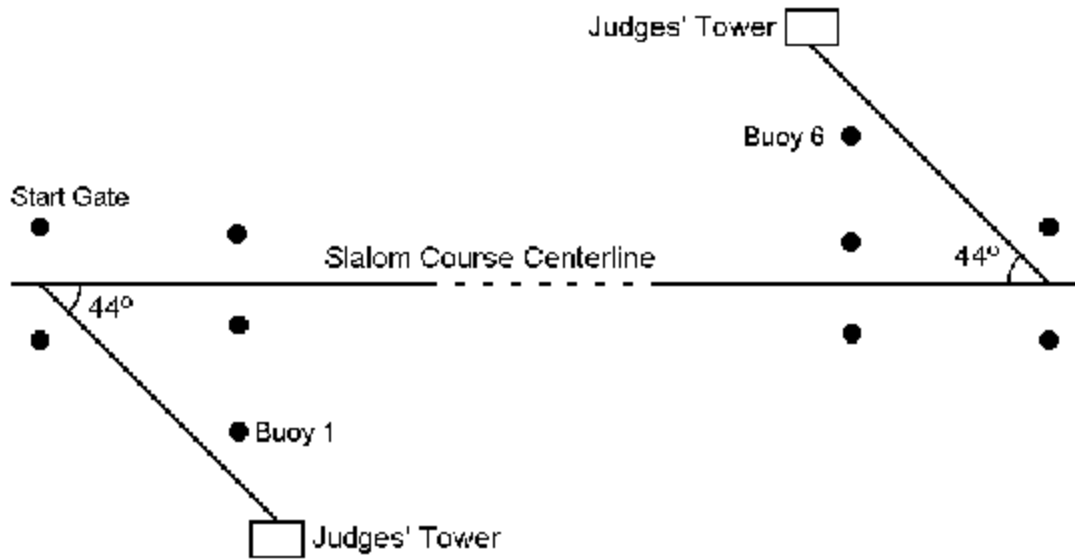

DIAGRAM 7 - PYLON SPECIFICATION DRAWING

The following diagram depicts the dimensions detailed in Rule 10.01(c).

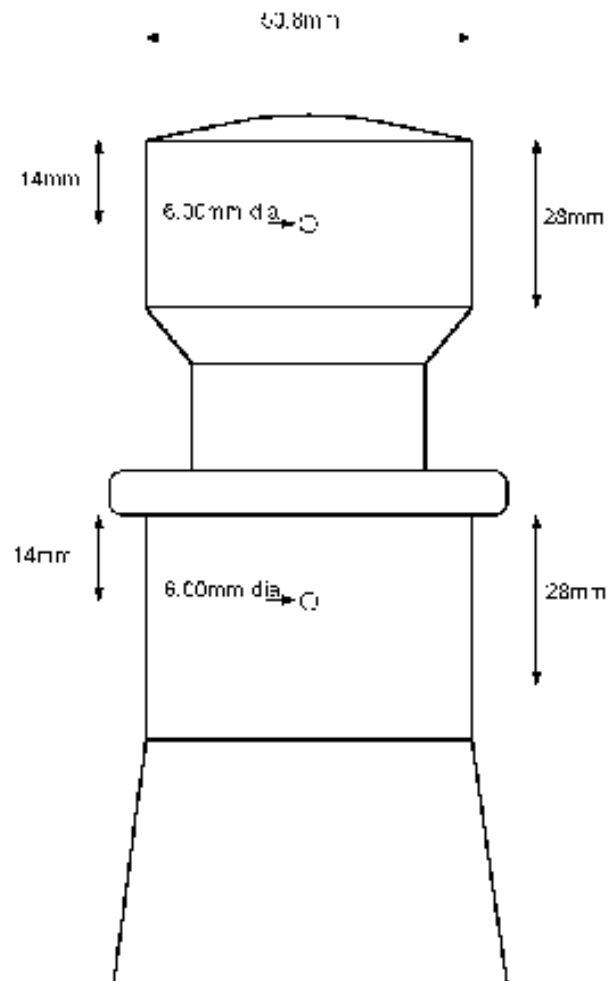

DIAGRAM 8 - ALLOWABLE STRUCTURE FOR A FLOATING COURSE

Each frame is separately attached to the cable.

The frame must be horizontal in the water.

The 2 main bars of the frame must be perpendicular, so the length of the guy wires must be calculated in order to have a 90° angle and keep the frame square.

CENTRE LINE SLALOM COURSE PRINCIPLE

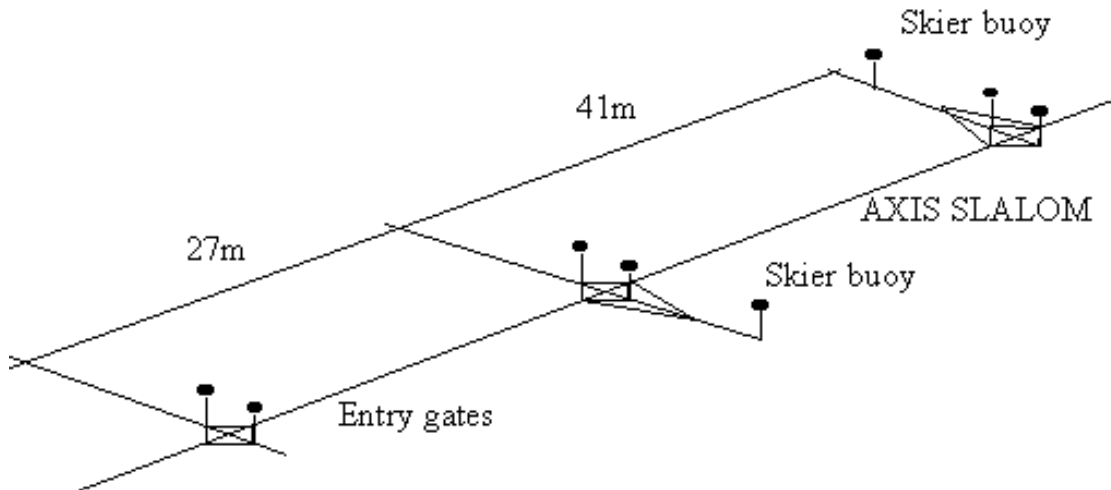

SLALOM - ENTRY GATES

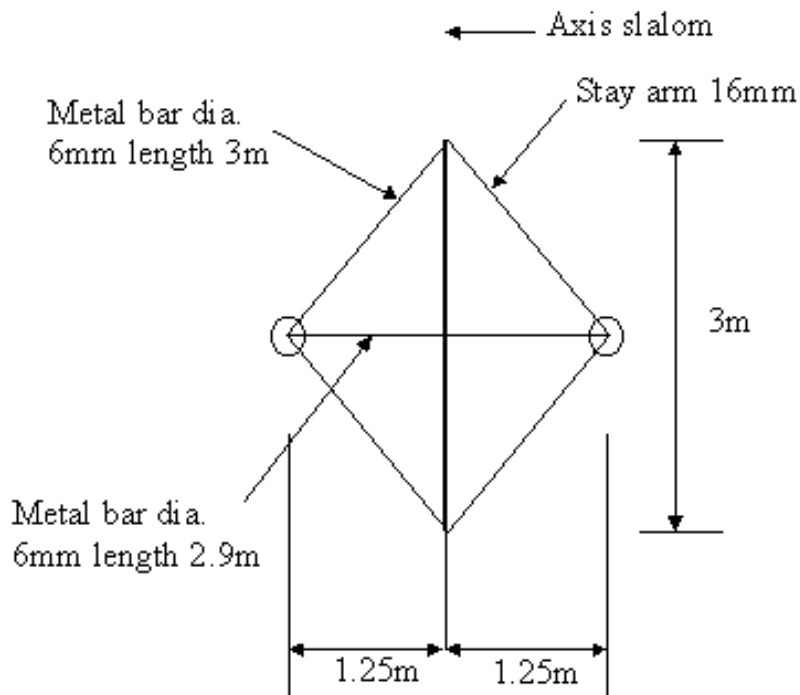

SLALOM FRAME

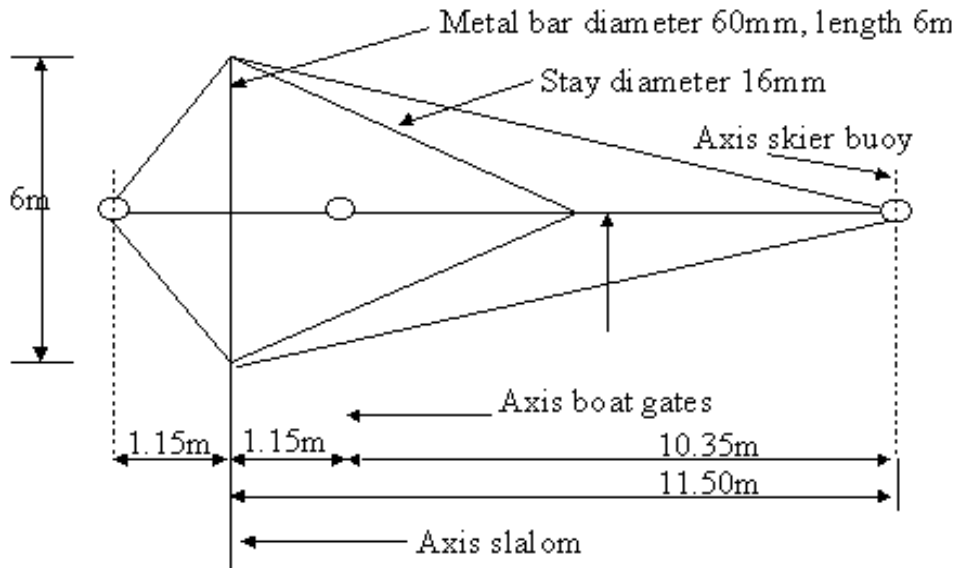
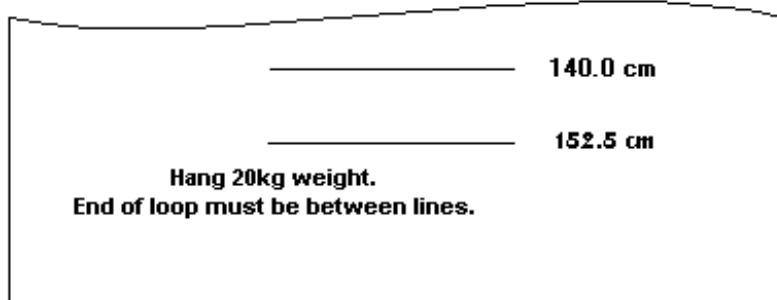
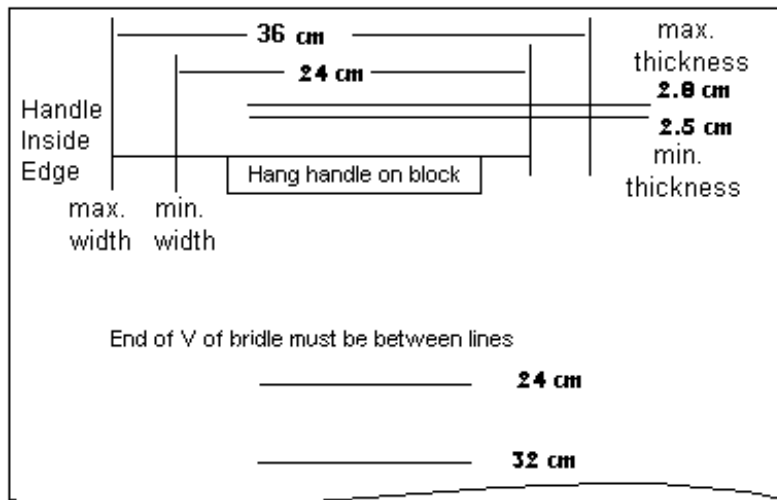

DIAGRAM 9 - HANDLE MEASUREMENT DEVICE DIMENSIONS

Typical handle measurement device.



COMPUTER BENCHMARK FOR COMPUTED DISTANCES NO LONGER REQUIRED

(Replaced by video jump measurement)

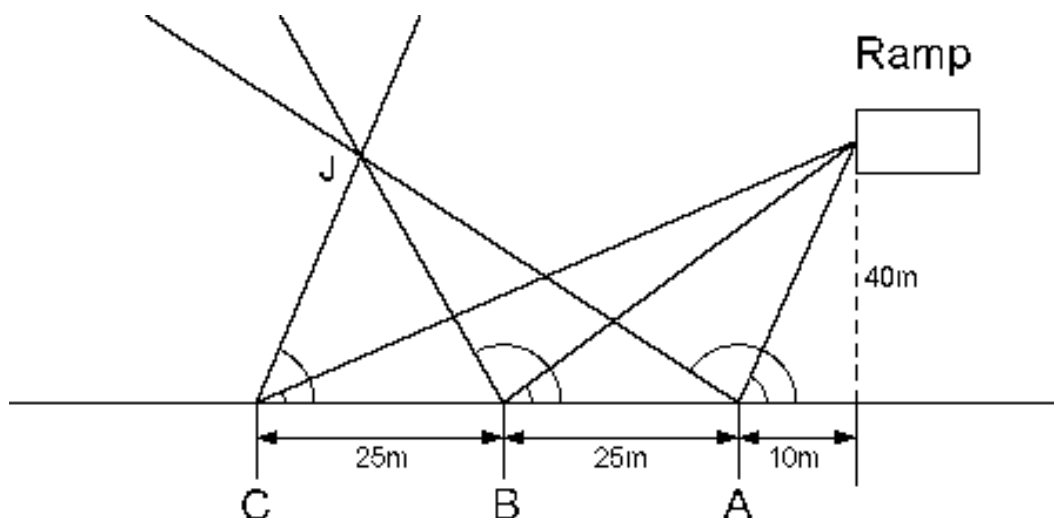

Distance AB=BC=25m

- A-B-C is a straight line

Jump position relative to A; 10m back, 40m out. - Jump is exactly parallel to ABC.

Note: The example shown is theoretical and does not imply that jump setups must conform to this diagram.

For jump distances and records to be certified, the jump meters must be set up so that the angles read from each station, using the official protractors, to the sighting mark (c.f. 13.02i) produce an error triangle with an inscribed circle diameter of less than or equal to 15cm.

Note: This does not apply if an alternative measurement system has been approved for use.

For the setup shown, some examples might be as follows:

A	B	C	X	Y	Tri.	Status
75.9638	48.8141	33.6901	10.0	40.0	0.0	OK
76.0	48.8	33.7	9.99	39.99	0.031	OK
75.9	48.9	33.6	9.94	39.93	0.169	BAD

Note: X and Y positions are rounded to .01m.

To verify that a computer program is computing distances according to the IWWF Rules, the operator must show that it produces identical results with the test cases that follow based on the setup given in the diagram. Note that triangle size is rounded to .001m

#	A	B	C	Dist	Trian
	Upper /Lower	Upper/Lower	Upper/Lower		
1.	136.6/136.6	106.8/106.8	65.6/65.6	45.5	0.0
2.	136.0/136.0	106.0/106.0	67.0/67.0	45.5	0.560
3.	136.9569/136.2431	107.2972/106.3028	66.073/65.127	45.5	0.0
4.	136.96/136.24	107.3/106.3	66.1/65.1	45.5	0.0
5.	136.6/137.32	106.8/107.8	66.6/65.6	45.5	0.0
6.	137.751/137.751	106.8/106.8	65.6/65.6	45.7	0.600
7.	137.753/137.753	106.8/106.8	65.6/65.6	45.3	0.601
8.	136.6/135.8	106.8/106.8	65.6/65.6	45.5	0.211
9.	136.7963/136.7963	106.8/106.8	65.6/65.6	45.5	0.103
10.	136.7964/136.7964	106.8/106.8	65.6/65.6	45.6	0.104

Case 7. Possible Reride - Longest Vertex 46.1 - Shortest Vertex 45.3

Specific Inscribed Circle Algorithm Description

(Note as one type of video system uses 3 cameras, this calculation method is still applicable)

Algebraic Solution of the Inscribed Circle where the absolute positions of the vertices of the triangle are known. This solution assumes that the triangle vertices have been found as required by normal trigonometric solution.

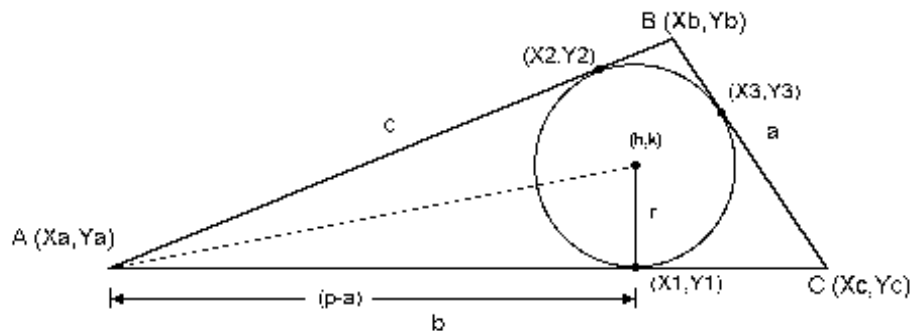

$$r = \sqrt{[(p-a)(p-c)/p]} \quad p = (a+b+c)/2$$

$$X1 = Xa + (p-a)(Xc - Xa)/b \quad X2 = Xa + (p-a)(Xb - Xa)/c \quad X3 = Xb + (p-b)(Xc - Xb)/a$$

$$Y1 = Ya + (p-a)(Yc - Ya)/b \quad Y2 = Ya + (p-a)(Yb - Ya)/c \quad Y3 = Yb + (p-b)(Yc - Yb)/a$$

Using the general formula $(X-h)^2 + (Y-k)^2 = r^2$, and substituting in $(X1, Y1)$, $(X2, Y2)$, $(X3, Y3)$ and solving the three equations simultaneously gives:

$$X1^2 - 2X1h + h^2 + Y1^2 - 2Y1k + k^2 - r^2 = 0 \quad (1)$$

$$X2^2 - 2X2h + h^2 + Y2^2 - 2Y2k + k^2 - r^2 = 0 \quad (2)$$

$$X3^2 - 2X3h + h^2 + Y3^2 - 2Y3k + k^2 - r^2 = 0 \quad (3)$$

Where subtracting (2) from (1) gives (4) and (3) from (2) gives (5)

$$X1^2 - 2X1h - X2^2 + 2X2h + Y1^2 - 2Y1k - Y2^2 + 2Y2k = 0 \quad (4)$$

$$X2^2 - 2X2h - X3^2 + 2X3h + Y2^2 - 2Y2k - Y3^2 + 2Y3k = 0 \quad (5)$$

Combining terms and reducing (4) gives (6): Combining terms and reducing (5) gives (7):

$$h(2X2 - 2X1) = -k(2Y2 - 2Y1) + Y2^2 - Y1^2 + X2^2 - X1^2 \quad (6)$$

$$h(2X3 - 2X2) = -k(2Y3 - 2Y2) + Y3^2 - Y2^2 + X3^2 - X2^2 \quad (7)$$

Substituting the following terms:

$$A = 2X2 - 2X1 \quad B = 2Y2 - 2Y1 \quad C = Y2^2 - Y1^2 + X2^2 - X1^2$$

$$D = 2X3 - 2X2 \quad E = 2Y3 - 2Y2 \quad F = Y3^2 - Y2^2 + X3^2 - X2^2$$

gives from (6) $h = (C - Bk)/A$ (8), and gives from (7) $h = (F - Ek)/D$ (9)

Since (8) = (9) $k((D \cdot C - A \cdot F)/(B \cdot D - A \cdot E))$ $h = (F - Ek)/D$

Where h is the X coordinate of the center of the inscribed circle and k is the Y coordinate of the center of the inscribed circle.

Note that if $X2 = X3$ the solution will not reduce and the vertices of the triangle will need to be re-labeled. This is also true of the denominator of k. However, since each of these values is calculated, the chance of this is exceedingly small, but a test should be made for it as it is certain to happen on a World Record jump.

Implementation of the Spread Rule - No Longer applicable

The wording of the rule is as follows:

If the top and bottom sightings from any single meter station are more than 0.6 meter apart at the point of landing, then the average value and the single sighting with the smaller value will each be tried in turn, and whichever of these produces the smaller triangle will be used to derive the official distance.

What the specific rule means is that using the distance from the meter station to the landing point calculated by using the average of the two angles at each station, find the angle whose tangent is 0.6m. If the difference between the top and bottom readings is greater than this calculated arc tangent, then it is too great a spread and the average angle and the angle that gives a closer point to the ramp (usually the smaller angle) are then used to determine the distance by using the one of these two readings that gives the lesser inscribed circle diameter.

Ramp Setting Chart

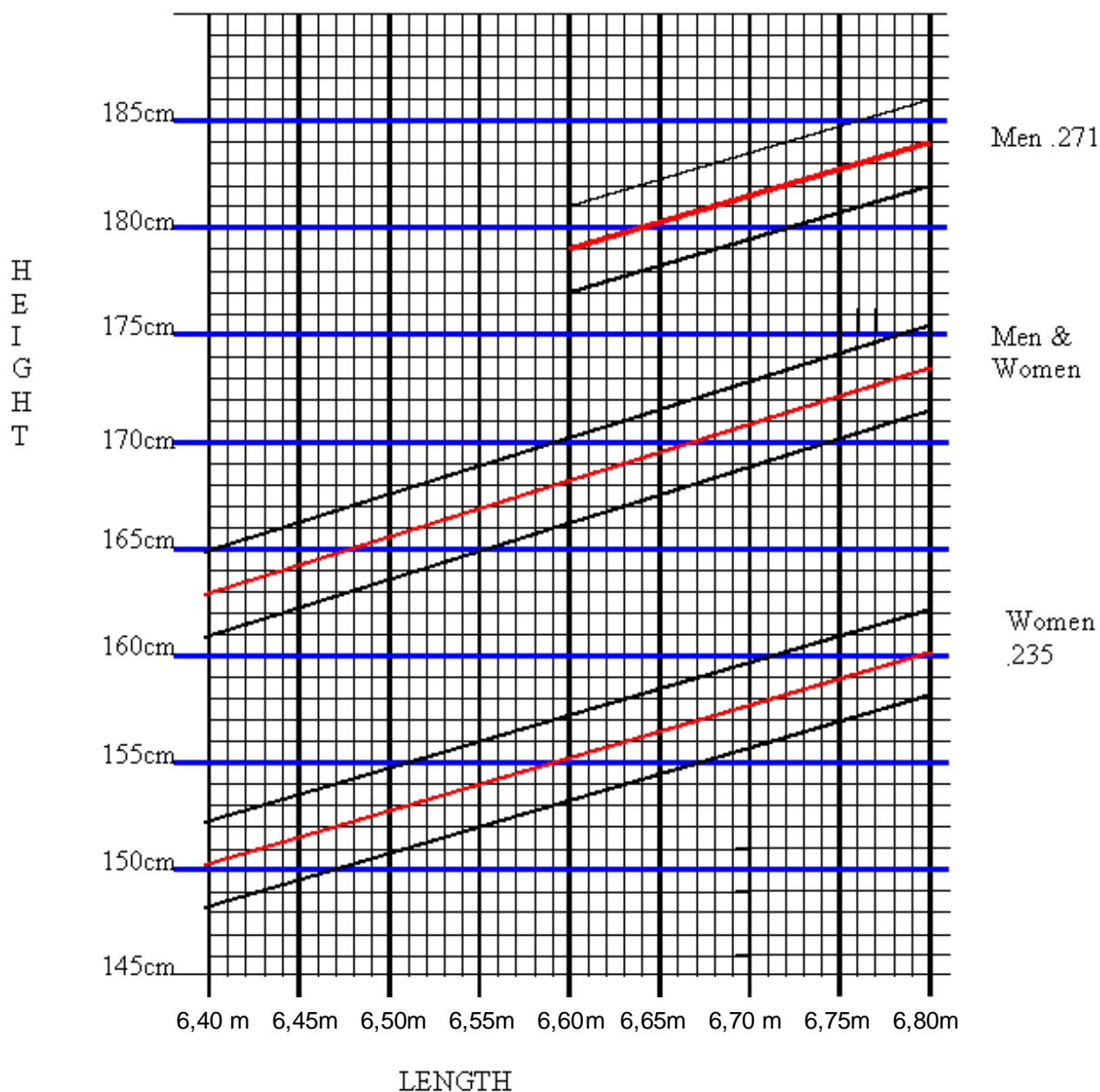

Instructions: For any particular ramp setting, a combination of HEIGHT at the top edge and LENGTH out of the water enclosed within the solid line is allowable. A combination that lies on the dotted (middle) line is the most desirable.

Homologation Dossier

International Water Ski Federation **2011** Edition Homologation Dossier

IMPORTANT NOTICE:

It is not the intent of this form to add hours of extra work to the homologator's job, but rather to provide a quick checklist that gives visibility of the technical effort to the general skiing public.

START OF HOMOLOGATION FORM

code of competition:

name of competition:

Date:

Venue:

Organizing Country:

GPS Location of site: _____

(example: Dubna 56 44 03.28 N 37 07 41.54 E World Championships)

Type of competition ()

Were cash prizes or merchandise awarded (Yes/No) ()

Homologator's and Chief Judge recommendation to Tournament Council

(Fill in R-Record, L-Standing List, N-Not list capable)

Event	Round 1	Round 2	Round 3	Round 4
Slalom	()	()	()	()
Tricks	()	()	()	()
Jump	()	()	()	()

OBLIGATORY COMPOSITION OF DOSSIER:

1 copy of this document including the homologation notice

HOMOLOGATOR'S CHECKLIST

If checked and all according to rules put OK in brackets.

If checked and any variation to the rules put an X in the brackets and explain in "Remarks" section on last page.

Not applicable is NA.

1. Boats and equipment (W 10.01) ()
2. Speed Control (W 10.07) ()
Manufacturer:
Software Version:
Slalom ()
Tricks ()
Jump ()
3. Arrangement for checking skis (W 10.03) ()
4. Measure lines and handles (W 10.04) ()
Slalom ()
Jump ()
Handles ()
5. Arrangement for checking of skier ()
supplied handles (W 10.06) ()
6. Timing devices (W 11.03) ()
7. Homologation notice posted before start ()
8. Automatic timing-jump ()

Optional Timing Method ()

9. Jump distance indication (W 13.11) ()
10. Video Jump Distance measurement (W 13.11) ()
Backup - video tape or standard meters ()
11. Automatic timing-slalom Dual Segment () All Buoys ()
12. Position and height of slalom towers () (W 14.05 and W diagram 6)
- 12a. 2 Towers x 2 Judges () 2 Central Tower Judges () Boat Video ()
13. Slalom buoys (W 14.06) ()
14. VHS video slalom endcourse (W 14.17) ()
15. Trick course checked (W diagram 3) ()
16. Position and height of trick towers () (W 15.11)
- 16a. 5 Judges () 1 x 3 Judges with video () 2x 3 Judges with video ()
17. Semi-automatic timing-20sec (W 15.12) () automatic median start ()
- 17a. Video Tricks Timing () with Additional judge () Chief Judge ()
18. VHS video tricks (W15.15) ()
- 19a. Video Tricks Timing system manufacturer (_____)
- 20. 2nd Speed Control Display used S/J ()**

SLALOM COURSE TYPE :

JUMP COURSE

JUMP MEASUREMENT SETUP

VIDEO JUMP

40m Test buoy

Survey x (XXX.XX) y (XXX.XX)

Video system x (XXX.XX) y (XXX.XX)

60m Test buoy

Survey x (XXX.XX) y (XXX.XX)

Video system x (XXX.XX) y (XXX.XX)

JUMP RAMP

Width at top (W 13.02a) X.XX m

Width at bottom X.XX m

Top edge to 6.4m line left side (W 13.02b,h) X.XX m

Top edge to 6.4m line right side (W 13.02b,h) X.XX m

Top edge to 6.7m line left side (W 13.02b,h) X.XX m

Top edge to 6.7m line right side (W 13.02b,h) X.XX m

Length underwater from 6.7m line (W 13.02c) X.XX m

Maximum Deviation from plane

Diagonal string measurement (W 13.02f) X.X cm

Center string measurement (W 13.02f) X.X cm

(OK/X)

Apron under water (W 13.02g) ()

Apron full length (W 13.02g) ()

Sighting line (W 13.02i) ()

Secure anchoring (W 13.02i) ()

Apron Angle (W 13.02k)
 jump height X.XX m (a)
 length of edge of apron from top corner to water X.XX m (b)
 ratio of b/a (X.XXX) ()
 minimum 0.883 maximum 0.643

RAMP SETTING

Setting	Height	Right Side		Left Side		
		Length	Ratio	Height	Length	Ratio
1.50	XXX.X	XXX.X	XXX.X	XXX.X	XXX.X	XXX.X
1.65	XXX.X	XXX.X	XXX.X	XXX.X	XXX.X	XXX.X
1.80	XXX.X	XXX.X	XXX.X	XXX.X	XXX.X	XXX.X

END OF HOMOLOGATION FORM

It is important to leave the above section in the exact format as it will be processed automatically. The following section is where free form comments are added and attachments are made.

HOMOLOGATOR'S REMARKS

Give details of any variations of IWWF rules. List any alterations to the course, etc. during the competition. List any malfunction of equipment. Give any further information which might affect the Tournament Council's assessment of the homologation.

Homologator:
 (name and address)

Email:

Chief Judge:
 (name and address)

Email:

This homologation record has to be uploaded to <http://www.iwwfed.com> for E&A: email also to Raymond Marc skiraymo@aol.com

To be posted before the tournament starts

HOMOLOGATION NOTICE

Tournament Name: _____

Date: _____

We recommend to the IWWF Tournament Council the following class of homologation:

Event	Round 1	Round 2	Round 3	Round 4
Slalom	(_____)	(_____)	(_____)	(_____)
Tricks	(_____)	(_____)	(_____)	(_____)
Jump	(_____)	(_____)	(_____)	(_____)

Speed Control Manufacturer: _____

Software Version: _____

Mode for tricks (if applicable): _____

Date _____

Time _____

Chief Judge

Homologator

Note: These recommendations may change during the competition.

Remarks:

